



EWH 80 H Water heater with double installation system and 80L capacity



Dry Heating Protection



Humidity Control



Type of Installation



Overheating Protection



ELCB Earth Leakage Circuit Breaker

DESCRIPTION

Water heater with double installation system and 80L capacity

LIFE STYLE

Total

COLOURS



REFERENCE

REF. 42080280
EAN. 8421152131961



TEKA

EWH 80 H

FEATURES

Vertical and horizontal installation
Capacity: 80 litres
Sapphire enamelled tank
Sapphire heating element
Regulation of temperature: 30-75 °C
Pressure valve > 5 bar
Max. Input temperature: 0,75Mpa
Thermometer
Anti Over-pressure protection
Earth leakage circuit breaker ELCB
Overheat protection
Anti Dry-heating Protection
Waterproof Grade: IPX4
Rated power output 1500 W
Thickness of insulation: 20mm
Water connection: G½
Average number of users: 2-4

DIMENSIONS

Product height (mm): 1030
Product width (mm): 385
Product depth (mm): 385
Product length (mm):
Net weight (Kg): 26,31

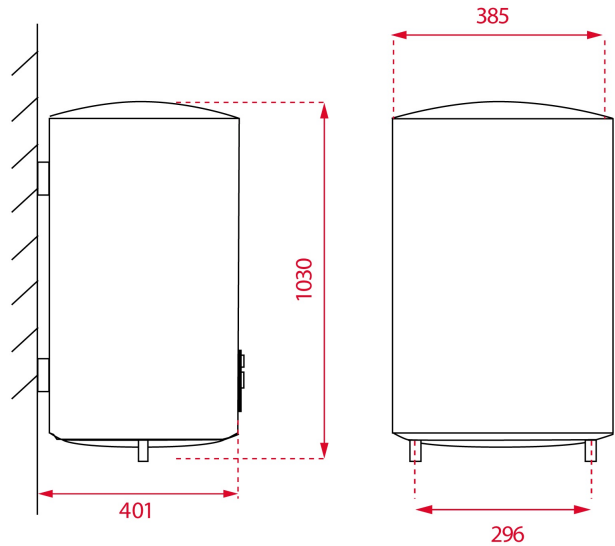

TECH SPECS

PARTICULAR CHARACTERISTICS

Power rate (V): 220-240
Frequency (Hz): 50
Power rate (W): 1.500
Plug type: EU
Type of installation: Vertical, Horizontal
Certificates: CE; CB
Average number of users: 2-4
Number of power levels: 1
Maximum input pressure (Mpa): 0,75
Sapphire Enamelled Steel Tank: Yes
Magnesium protection anode: Yes
Heating element indicator lamp: Yes
Thermometer: Yes
Insulation thickness (mm): 20,00
Degree of protection against humidity: IPX4
Protection against heating: Yes
Dry heating protection: Yes

EU REGULATION NO.
812/2013

Declared load profile: M
Water heating energy efficiency class: C
Annual energy consumption AEC kWh/annum (kWh): 1422,00
Sound power level L WA (dB): 15



EWH 80 H

ENERGY LABEL

