









# MaestroPizza HLB 8510 P MaestroPizza pyrolytic oven with special pizza function 340°C



-  70 L
-  HydroClean
-  Plus Extension Telescopic Guide
-  Pyrolysis
-  SoftClose
-  SurroundTemp

**DESCRIPTION**

MaestroPizza pyrolytic oven with special pizza function 340°C

**COLOURS**



**REFERENCE**

REF. 111000046  
EAN. 8434778017489

**FEATURES**

MaestroPizza oven  
Urban Colors Edition  
Multifunction SurroundTemp oven  
8 cooking functions  
Up to 340°C in cavity for perfect pizza finish  
Temperature range for traditional recipes: 50-250°  
Pyrolysis self-cleaning system and automatic HydroClean system  
Touch control display with knobs  
Electronic timer(Delay/Start function)  
Chrome supports with 5 cooking levels  
Plus Extension Telescopic guides  
Removable quadruple glazed door  
SoftClose system  
Automatic disconnection security system  
Children safety lock  
Manual quick heating  
Anti-tip deep tray, baking tray and reinforced grid  
Special pizza stone included  
Capacity (gross/net): 71 / 70 litres

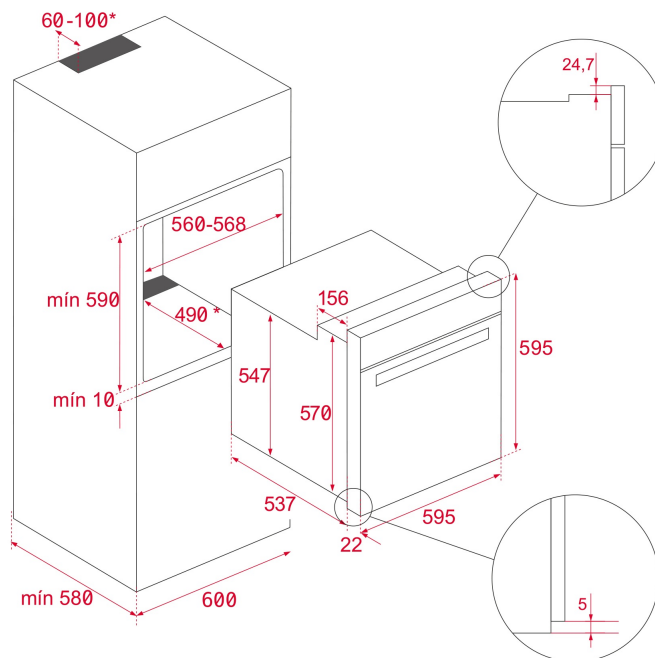

## DIMENSIONS

**Product height (mm):** 595

**Product width (mm):** 595

**Product depth (mm):** 537+22

**Product length (mm):**

**Net weight (Kg):** 34

## TECHNICAL DETAILS

### FEATURES

**Certificates:** CE

**Number of cavities:** 1

**Enamelled cavity:** Yes

**Min. Temperature Regulator (°C):** 50

**Max. Temperature Regulator (°C):** 250

**Function selector:** 11+0

**Number of cooking functions:** 8

**Top + Bottom function:** Yes

**Grill function:** Yes

**MaxiGrill function:** Yes

**Bottom + TURBO (Pizza) function:** Yes

**Turbo function:** Yes

**ECO function:** Yes

**Mechanical quick heating:** Yes

**Touch Control Programmer:** Yes

**Removable chromed tray guides:** Yes

**Number of guide levels:** 5

**Easy slide telescopic guides:** Yes

**SoftClose:** Yes

**Maximum Nominal Power (W):** 3552

**Frequency (Hz):** 50/60

**Power rate (V):** 220-240

**Cable Connection Length (cm):** 150

**Plug:** Yes

**Inside light Consumption (W):** 25

## **ENERGY CONSUMPTION**

**Energy consumption per cycle in conventional mode (kWh):**  
0.88

**Energy consumption per cycle in fan-forced convection mode (kWh):** 0,68

**Bottom Heating Element (W):** 1050

**Grill (W):** 1400

**Maxi Grill (W):** 2450

**Traditional (W):** 2450

**Turbo (W):** 2000

**Multifunction Turbo (W):** 25

**Cooling Fan Motor (W):** 30

## **SAFETY SYSTEMS**

**Automatic disconnection when opening the door:** Yes

**Panel blocking system:** Yes

**Children safety block option:** Yes

**Grill protection:** Yes

**Anti-tip tray system:** Yes

**Safety Thermostat:** Yes

## **CLEANING SYSTEM**

**Crystal Clean Enamel (Slippery):** Yes

**Hydroclean PRO:** Yes

**Pyrolytic:** Yes

**DualClean:** Yes

## **ACCESSORIES**

**Baking Tray:** 1

**Deep Tray (50 mm):** 1

**Reinforced grid:** 1

## **ENERGY EFFICIENCY**

**Energy Efficiency Class:** A+

**Energy Efficiency Index (EEI):** 81



# MaestroPizza HLB 8510 P

## ENERGY LABEL

