



DVT 98660 TBS 90cm Vertical Decorative Hood in full glass design and FreshAir function



LED



Perimeter extraction



Stop Delay Timer



Fresh AIR

DESCRIPTION

90cm Vertical Decorative Hood in full glass design and FreshAir function

LIFE STYLE

Maestro

COLOURS



REFERENCE

REF. 112930043
EAN. 8434778013252

FEATURES

Vertical decorative hood
Rim extraction system
Touch control display
FreshAir function
Full glass design
3 speeds + intensive
Stop delay timer
LED illumination
Saturation filter indicator
EcoPower motor
Exhausts capacity: min.307 m³/h – max.698 m³/h
Sound level: min.61 dB – max.72 dB
Recirculation function with or without tube cover
Optional regenerative charcoal filters
Installation also possible without tube cover

DIMENSIONS

Product height (mm): 800-1100
Product width (mm): 900
Product depth (mm): 412
Product length (mm):
Net weight (Kg): 16,2

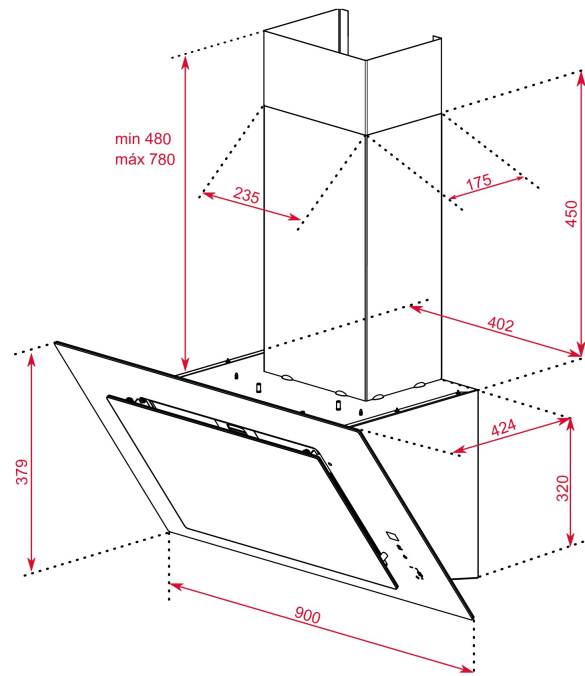

TECH SPECS

PARTICULAR CHARACTERISTICS

Type of hood: Vertical
Style: Decoratives
Ø Outlet (mm): 150
Removable oil collector: Yes
Dual Aspiration System: Yes
Type of inner light: LED
Inside light Consumption (W): 4
Plug type: Schuko plug
Cable Connection Length (cm): 100
Power rate (V): 220/240
Frequency (Hz): 50/60
Total hood power (W): 286
Number of motors: 1
Motor power (W): 280

**EU REGULATION NO. 65/2014
&66/2104**

Annual energy consumption AEC kWh/annum (kWh): 38,7
Energy Efficiency Class: A+
Fluid Dynamic Efficiency (FDEhood): 35,1
Fluid Dynamic Efficiency class: A
Light Efficiency (Lehood) lux/Watt: 69,8

Lighting Efficiency class: A
Grease Filtering Efficiency class: C
Air flow (Qmin) m3/h: 307
Air flow (Qmax): 584
Air flow (Qboost): 698
Noise (LwA) Min Speed (dB): 61
Noise (LwA) Max Speed (dB): 72
Noise (LwA) boost speed (dB): 74
Off mode Power (Po) W: 0
Standby Power (Ps) W: 0,74
Energy Efficiency Index (EEI): 41
Time increase factor: 0,7
Electric power input at best efficiency point (Wbep) W: 140
Nominal power of the lighting system (WL) W: 4,2
Average illumination of the lighting system on the cooking surface (Emiddle) Lux: 419

ACCESSORIES

Anti Return valve: Yes
Outlet reduction: Yes
Optional Charcoal Filter: C1RTK
Charcoal filter description: Conventional charcoal filter
Conventional recirculation kit (with tube cover): 113290017
Regenerative recirculation kit (with tube cover): 113290011
Conventional recirculation kit (without tube cover): 113290016
Regenerative recirculation kit (without tube cover): 113290012

MODELS

Number of filters: 2
Filter description: Aluminum Filters
Opening system: Piston
Control panel: Touch Control w/display
Stop delay timer: Yes
Filter saturation indicator: Yes
Number of speeds: 3 + 1
Fresh air function: Yes

PRODUCT INFORMATION SHEET - DELEGATED REGULATION (EU) 65/2014

Supplier name or trademark: TEKA
Model identifier: DVT 98660 TBS
Annual Energy Consumption: 38,7
Energy Efficiency Class: A+
Fluid Dynamic Efficiency: 35,1
Fluid Dynamic Efficiency class: A
Lighting Efficiency: 69,8
Lighting Efficiency class: A
Grease Filtering Efficiency:
Grease Filtering Efficiency class: C
Air flow (min speed normal use): 307
Air flow (max speed normal use): 584
Air flow (intensive or boost use): 698
Airborne acoustical A-weighted sound power emissions (min speed normal use): 60.8
Airborne acoustical A-weighted sound power emissions (max speed normal use): 72
Airborne acoustical A-weighted sound power emissions (intensive or boost use): 73.6
Power consumption in off mode (W): 0
Power consumption in standby mode (W): 0,74



DVT 98660 TBS

ENERGY LABEL

