



DVT 68660 TBS 60cm Vertical Decorative Hood in full glass design and FreshAir function



A Energy Class



LED



Perimeter extraction



Stop Delay Timer



Fresh AIR

DESCRIPTION

60cm Vertical Decorative Hood in full glass design and FreshAir function

LIFE STYLE

Maestro

COLOURS



REFERENCE

REF. 112930040
EAN. 8434778013221

FEATURES

Vertical decorative hood
Rim extraction system
Touch control display
FreshAir function
Full glass design
3 speeds + intensive
Stop delay timer
LED illumination
Saturation filter indicator
EcoPower motor
Exhausts capacity: min.307 m³/h – max.698 m³/h
Sound level: min.61 dB – max.72 dB
Recirculation function with or without tube cover
Optional regenerative charcoal filters
Installation also possible without tube cover

DIMENSIONS

Product height (mm): 380
Product width (mm): 600
Product depth (mm): 412
Product length (mm):
Net weight (Kg): 14,5

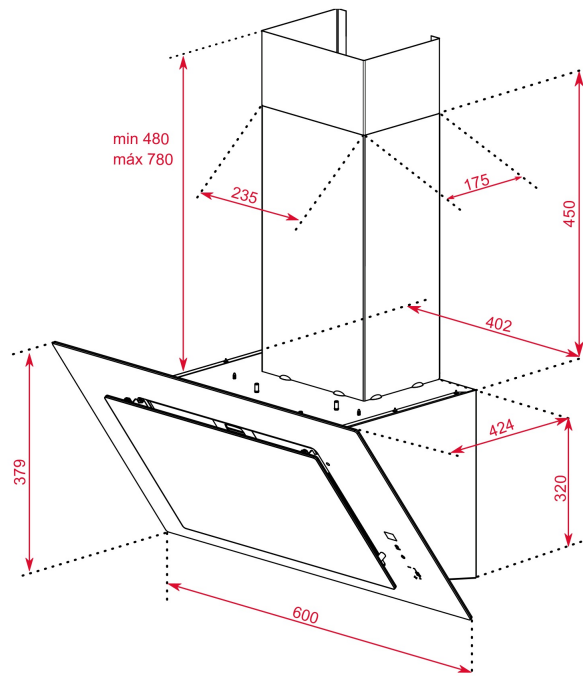

TECH SPECS

PARTICULAR CHARACTERISTICS

Type of hood: Vertical
Style: Decoratives
Ø Outlet (mm): 150
Removable oil collector: Yes
Dual Aspiration System: Yes
Type of inner light: LED
Inside light Consumption (W): 4
Plug type: Schuko plug
Cable Connection Length (cm): 100
Power rate (V): 220-240
Frequency (Hz): 50/60
Total hood power (W): 286
Number of motors: 1
Motor power (W): 280

**EU REGULATION NO. 65/2014
 &66/2104**

Annual energy consumption AEC kWh/annum (kWh): 38,7
Energy Efficiency Class: A+
Fluid Dynamic Efficiency (FDEhood): 35,1
Fluid Dynamic Efficiency class: A
Light Efficiency (Lehood) lux/Watt: 69,8

Lighting Efficiency class: A
Grease Filtering Efficiency class: C
Air flow (Qmin) m³/h: 307
Air flow (Qmax): 584
Air flow (Qboost): 698
Noise (LwA) Min Speed (dB): 61
Noise (LwA) Max Speed (dB): 72
Noise (LwA) boost speed (dB): 74
Off mode Power (Po) W: 0
Standby Power (Ps) W: 0,74
Energy Efficiency Index (EEI): 41
Time increase factor: 0,7
Electric power input at best efficiency point (Wbep) W: 140
Nominal power of the lighting system (WL) W: 4,2
Average illumination of the lighting system on the cooking surface (Emiddle) Lux: 419

ACCESSORIES

Anti Return valve: Yes
Outlet reduction: Yes
Optional Charcoal Filter: C1RTK
Charcoal filter description: Conventional charcoal filter
Conventional recirculation kit (with tube cover): 113290017
Regenerative recirculation kit (with tube cover): 113290011
Conventional recirculation kit (without tube cover): 113290016
Regenerative recirculation kit (without tube cover): 113290012

MODELS

Filter description: Aluminum Filters
Opening system: Piston
Control panel: Touch Control w/display
Stop delay timer: Yes
Filter saturation indicator: Yes
Number of speeds: 3 + 1
Fresh air function: Yes



DVT 68660 TBS

ENERGY LABEL

