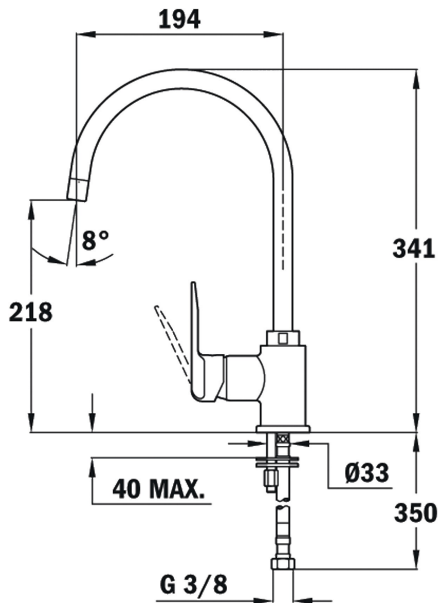

Anti-scale  
aeratorSwivel  
spout

## REFERENCE

REF: 55995020S

EAN: 8421152102220

## FEATURES

High spout kitchen tap

Swivel spout

Anti-scale aerator

Cartridge with ceramic discs of high resistance

Highly precise temperature control







Greater handling sensitivity with smoother movements

3/8" flexible inlet pipes

## DIMENSIONS

**Product height (mm):****Product width (mm):****Product depth (mm):****Product length (mm):****Net weight (Kg):** 1,55

## COLOURS

	55995020S	Sandbeige
	559950200	Topasbeige
	559950200	Metallic black
	559950200	Carbon
	559950200	Stainless steel
	559950200	Chrome