



C 6420 60cm Classical integrated Hood with 2 motors



LED

DESCRIPTION

60cm Classical integrated Hood with 2 motors

LIFE STYLE

Easy

COLOURS



REFERENCE

REF. 40465532
EAN. 8421152146101

FEATURES

Classic hood
Operating pilot light
3 speeds
Exhaust capacities:
Free Outlet, m³/h: 422
Max., m³/h: 375
Min., m³/h: 141
Noise (LwA) Max Speed, dB: 72
Noise (LwA) Min Speed, dB: 60
2 Integrated LED lamps
3 aluminium filters

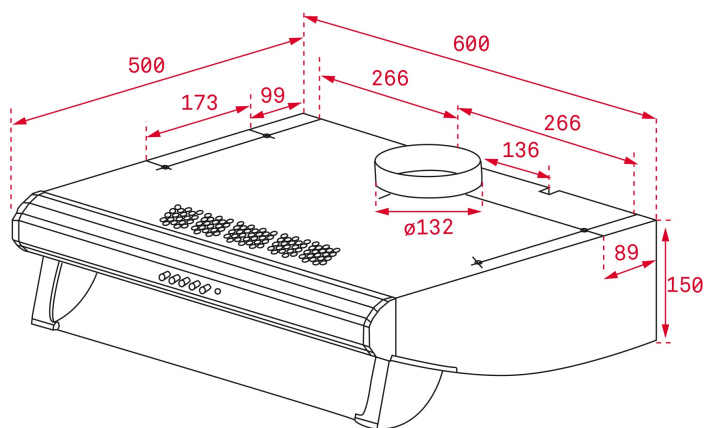

DIMENSIONS

Product height (mm): 150
Product width (mm): 600
Product depth (mm): 500
Product length (mm):
Net weight (Kg): 8,05

TECH SPECS

PARTICULAR CHARACTERISTICS

Type of hood: Classic
Style: Integrated
Certificates: CE; CB; Rohs
Ø Outlet (mm): 120
Type of inner light: LED
Inside light Consumption (W): 6
Plug type: European plug
Power rate (V): 220240
Frequency (Hz): 5060
Total hood power (W): 192
Number of motors: 2
Motor power (W): 180
Exhaust Capacity - Free Outlet (m3/h): 422

**EU REGULATION NO. 65/2014
&66/2104**

Annual energy consumption AEC kWh/annum (kWh): 103,1
Energy Efficiency Class: D
Fluid Dynamic Efficiency (FDEhood): 8,9
Fluid Dynamic Efficiency class: E
Light Efficiency (Lehood) lux/Watt: 4,8
Lighting Efficiency class: F

Grease Filtering Efficiency class: D
Air flow (Qmin) m3/h: 187
Air flow (Qmax): 353
Noise (LwA) Min Speed (dB): 60
Noise (LwA) Max Speed (dB): 72
Energy Efficiency Index (EEI): 97,7
Time increase factor: 1,7
Electric power input at best efficiency point (Wbep) W: 152,0
Nominal power of the lighting system (WL) W: 12
Average illumination of the lighting system on the cooking surface (Emiddle) Lux: 58

ACCESSORIES

Anti Return valve: Yes
Outlet extension: Yes
Optional Charcoal Filter: C1R
Charcoal filter description: CHARCOAL FILTER C1R

MODELS

Number of filters: 2
Filter description: Aluminum
Control panel: Slider
Number of speeds: 3

PRODUCT INFORMATION SHEET - DELEGATED REGULATION (EU) 65/2014

Supplier name or trademark: TEKA
Model identifier: C 6420
Annual Energy Consumption: 103,1
Energy Efficiency Class: D
Fluid Dynamic Efficiency: 8,9
Fluid Dynamic Efficiency class: E
Lighting Efficiency: 4,8
Lighting Efficiency class: F
Grease Filtering Efficiency class: D
Air flow (min speed normal use): 187
Air flow (max speed normal use): 353
Air flow (intensive or boost use): n.a
Airborne acoustical A-weighted sound power emissions (min speed normal use): 60
Airborne acoustical A-weighted sound power emissions (max speed normal use): 73
Power consumption in off mode (W): n.a
Power consumption in standby mode (W): n.a



C 6420

ENERGY LABEL

