



DSJ 650 60cm Ultraslim Decorative Hood



LED

DESCRIPTION

60cm Ultraslim Decorative Hood

LIFE STYLE

Easy

COLOURS



REFERENCE

REF. 40484830
EAN. 8421152157282



TEKA

DSJ 650

FEATURES

Ultraslim decorative hood
Double turbine motor
Energy Efficiency class: D
Conventional aspiration
3 speeds
Exhaust capacities:
Max. (m³/h): 401
Min. (m³/h): 231
Noise (LwA) Max Speed 58 dB
Noise (LwA) Min Speed 43 dB
2 LED illumination
2 stainless steel-aluminium filter
Possibility of operation in recirculation (SET D1CTP)

DIMENSIONS

Product height (mm): 670-1000
Product width (mm): 900
Product depth (mm): 480
Product length (mm):
Net weight (Kg): 13,37

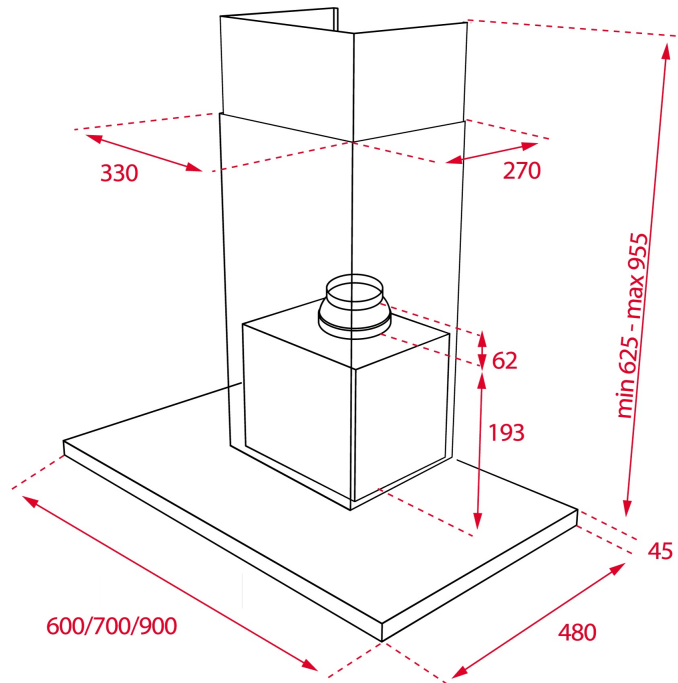

TECH SPECS

PARTICULAR CHARACTERISTICS

Type of hood: Horizontal
Style: Decoratives
Certificates: CE; CB; Rohs
Ø Outlet (mm): 150
Type of inner light: LED
Inside light Consumption (W): 3
Plug type: Schuko plug
Power rate (V): 220240
Frequency (Hz): 50
Total hood power (W): 113
Number of motors: 1
Motor power (W): 110
Exhaust Capacity - Free Outlet (m3/h): 430

**EU REGULATION NO. 65/2014
&66/2104**

Annual energy consumption AEC kWh/annum (kWh): 62,7
Energy Efficiency Class: D
Fluid Dynamic Efficiency (FDEhood): 9,5
Fluid Dynamic Efficiency class: E
Light Efficiency (Lehood) lux/Watt: 35,0
Lighting Efficiency class: A

Grease Filtering Efficiency class: D
Air flow (Qmin) m3/h: 235
Air flow (Qmax): 433
Noise (LwA) Min Speed (dB): 43
Noise (LwA) Max Speed (dB): 58
Energy Efficiency Index (EEI): 88,8
Time increase factor: 1,7
Electric power input at best efficiency point (Wbep) W: 97,5
Nominal power of the lighting system (WL) W: 3
Average illumination of the lighting system on the cooking surface (Emiddle) Lux: 105

ACCESSORIES

Anti Return valve: Yes
Outlet reduction: Yes
Optional Charcoal Filter: D1C
Charcoal filter description: CHARCOAL FILTER D1C
Conventional recirculation kit (with tube cover): 40490150

MODELS

Number of filters: 2
Filter description: Aluminum
Control panel: Rectangular Push Buttons
Number of speeds: 3

PRODUCT INFORMATION SHEET - DELEGATED REGULATION (EU) 65/2014

Supplier name or trademark: TEKA
Model identifier: DSJ 650
Annual Energy Consumption: 62,7
Energy Efficiency Class: D
Fluid Dynamic Efficiency: 9,5
Fluid Dynamic Efficiency class: E
Lighting Efficiency: 35,0
Lighting Efficiency class: A
Grease Filtering Efficiency class: D
Air flow (min speed normal use): 235
Air flow (max speed normal use): 433
Airborne acoustical A-weighted sound power emissions (min speed normal use): 43
Airborne acoustical A-weighted sound power emissions (max speed normal use): 58

