



**DVT 68660 TBS** 60cm Vertical Decorative Hood in full glass design and FreshAir function



LED



Perimeter extraction



Stop Delay Timer



Fresh AIR

**DESCRIPTION**

60cm Vertical Decorative Hood in full glass design and FreshAir function

**LIFE STYLE**

Maestro

**COLOURS**



**REFERENCE**

REF. 112930039  
EAN. 8434778013214

**FEATURES**

Vertical decorative hood  
Rim extraction system  
Touch control display  
FreshAir function  
Full glass design  
3 speeds + intensive  
Stop delay timer  
LED illumination  
Saturation filter indicator  
EcoPower motor  
Exhausts capacity: min.307 m<sup>3</sup>/h - max.698 m<sup>3</sup>/h  
Sound level: min.61 dB - max.72 dB  
Recirculation function with or without tube cover  
Optional regenerative charcoal filters  
Installation also possible without tube cover

## DIMENSIONS

**Product height (mm):** 800-1100  
**Product width (mm):** 600  
**Product depth (mm):** 412  
**Product length (mm):**  
**Net weight (Kg):** 14,5

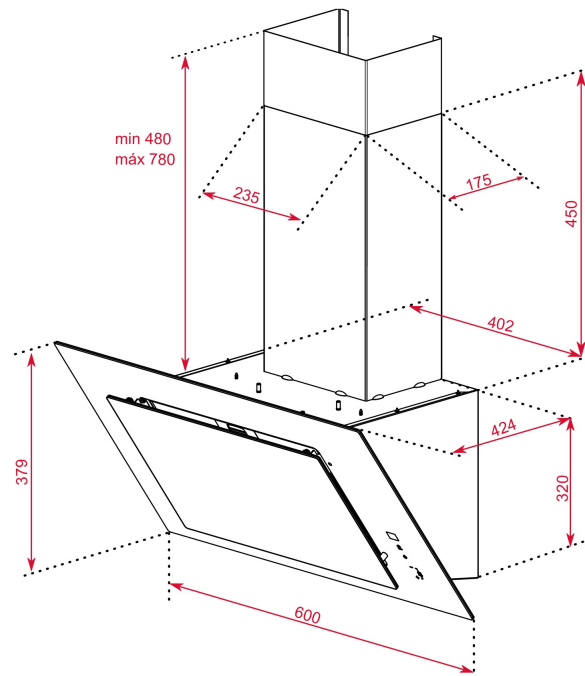

## TECH SPECS

### PARTICULAR CHARACTERISTICS

**Ø Outlet (mm):** 150  
**Removable oil collector:** Yes  
**Dual Aspiration System:** Yes  
**Type of inner light:** LED  
**Inside light Consumption (W):** 4  
**Plug type:** Schuko plug  
**Cable Connection Length (cm):** 100  
**Power rate (V):** 220/240  
**Frequency (Hz):** 50/60  
**Total hood power (W):** 286  
**Number of motors:** 1  
**Motor power (W):** 280

**EU REGULATION NO. 65/2014  
&66/2104**

**Annual energy consumption AEC kWh/annum (kWh):** 38,7  
**Energy Efficiency Class:** A+  
**Fluid Dynamic Efficiency (FDEhood):** 35,1  
**Fluid Dynamic Efficiency class:** A  
**Light Efficiency (Lehood) lux/Watt:** 69,8  
**Lighting Efficiency class:** A  
**Grease Filtering Efficiency class:** C

**Air flow (Qmin) m3/h:** 307  
**Air flow (Qmax):** 584  
**Air flow (Qboost):** 698  
**Noise (LwA) Min Speed (dB):** 61  
**Noise (LwA) Max Speed (dB):** 72  
**Noise (LwA) boost speed (dB):** 74  
**Off mode Power (Po) W:** 0  
**Standby Power (Ps) W:** 0,74  
**Energy Efficiency Index (EEI):** 41  
**Time increase factor:** 0,7  
**Air pressure at best efficiency point(Pbep) Pa:** 488  
**Electric power input at best efficiency point (Wbep) W:** 140  
**Nominal power of the lighting system (WL) W:** 4,2  
**Average illumination of the lighting system on the cooking surface (Emiddle) Lux:** 419

## ACCESSORIES

**Anti Return valve:** Yes  
**Outlet reduction:** Yes  
**Optional Charcoal Filter:** C1RTK  
**Charcoal filter description:** Conventional charcoal filter

## MODELS

**Number of filters:** 2  
**Filter description:** Aluminum Filters  
**Opening system:** Piston  
**Control panel:** Touch Control w/display  
**Stop delay timer:** Yes  
**Filter saturation indicator:** Yes  
**Number of speeds:** 3 + 1  
**Fresh air function:** Yes

## PRODUCT INFORMATION SHEET - DELEGATED REGULATION (EU) 65/2014

**Supplier name or trademark:** TEKA  
**Model identifier:** DVT 68660 TBS  
**Annual Energy Consumption:** 38,7  
**Energy Efficiency Class:** A+  
**Fluid Dynamic Efficiency:** 35,1  
**Fluid Dynamic Efficiency class:** A  
**Lighting Efficiency:** 69,8  
**Lighting Efficiency class:** A  
**Grease Filtering Efficiency class:** C  
**Air flow (min speed normal use):** 307  
**Air flow (max speed normal use):** 584  
**Air flow (intensive or boost use):** 698  
**Airborne acoustical A-weighted sound power emissions (min speed normal use):** 60.8  
**Airborne acoustical A-weighted sound power emissions (max speed normal use):** 72  
**Airborne acoustical A-weighted sound power emissions (intensive or boost use):** 73.6  
**Power consumption in off mode (W):** 0  
**Power consumption in standby mode (W):** 0,74



DVT 68660 TBS

ENERGY LABEL

