



Almost everything that matters to **us happens** in kitchen



COLD LINE



# The kitchen is the **heart** of a home

Cooking for family and friends, a table talk after a long working day, and afternoon snack with the kids. That's how I take care of my beloved ones, putting together good times with delicious food, in the best and cosy environment. Some kitchens are so special that turns moments into unforgettable memories.



## ***Connect with your kitchen through design***

A remarkable appearance French Door design. It takes care of all the details including a touch control display with white LED illumination, the perfect combination with the unique and exclusive black glass finish.

## ***LongLife No Frost***

Keep your food perfect: goal achieved. LongLife No Frost technology keeps every compartment at the perfect moisture level thanks to the three independent cooling circuits. Your food remains fresh for longer.

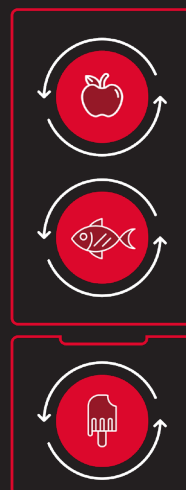

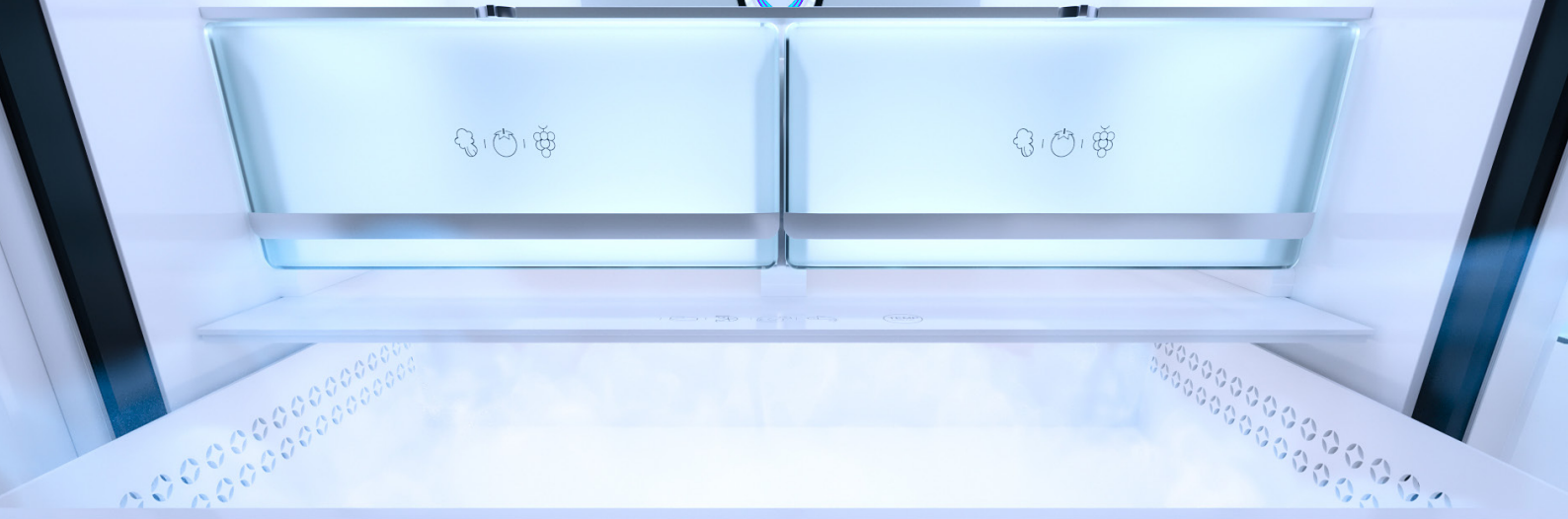

## Gourmet Box

*Precision is to keep food at perfect temperature*

Your food remains fresh for longer at the perfect temperature. The latest technology of the 0°C box. Gourmet Box, a soft close telescopic drawer, allows you to choose the right temperature between -2 and 3°C through a touching display at the top. Welcome to wellness.



## IonClean Technology

IonClean technology create negative ions that neutralise bacteria and bad smell particles. Air inside the fridge will be superb this way and always fresh and free of odours.



## Motor inverter

*Silence, durability and efficiency*

Feel the peace at home. Less consumption and more silence with the inverter compressor. This motor produces less friction and it has a lower energy consumption, being more silence and long-lasting. Want to take care of stillness and quietness at your home, but we also want to save you money. Our refrigerators and freezers range is designed thinking about efficiency. Save more with the most advanced technology.

## TempGuard

TempGuard Radar system controls and keeps the temperature thanks to sensors located inside. Any change is automatically fixed. Your fridge always at the real temperature your food needs.



## VitaCare Box

From farm to table VitaCareBox drawer has a personalised moisture control to keep your fruit and vegetables always fresh, preserving all their vitamins and nutrients for longer.

## From freezer to fridge in just one touch

Room enough to keep food cold or even freeze it, thanks to the compartment with adjustable temperature: from cold to frozen. You can set the temperature you want to from  $-18^{\circ}\text{C}$  to  $7^{\circ}\text{C}$  and have a complete control of your food and appliance. At your service.



## Complete flexibility to store your food

With the flexirack system, just pressing a side button, you can adjust the height of the door shelf anytime you need it!



## Just on Touch away from your refreshing drink

Take drinks without opening the door with just one touch. Easy access to a special compartment for drinks avoiding open the whole refrigerator. The BarOnDoor goes beyond an intelligent design, thereby saving energy.

*Feel the comfort saving money*

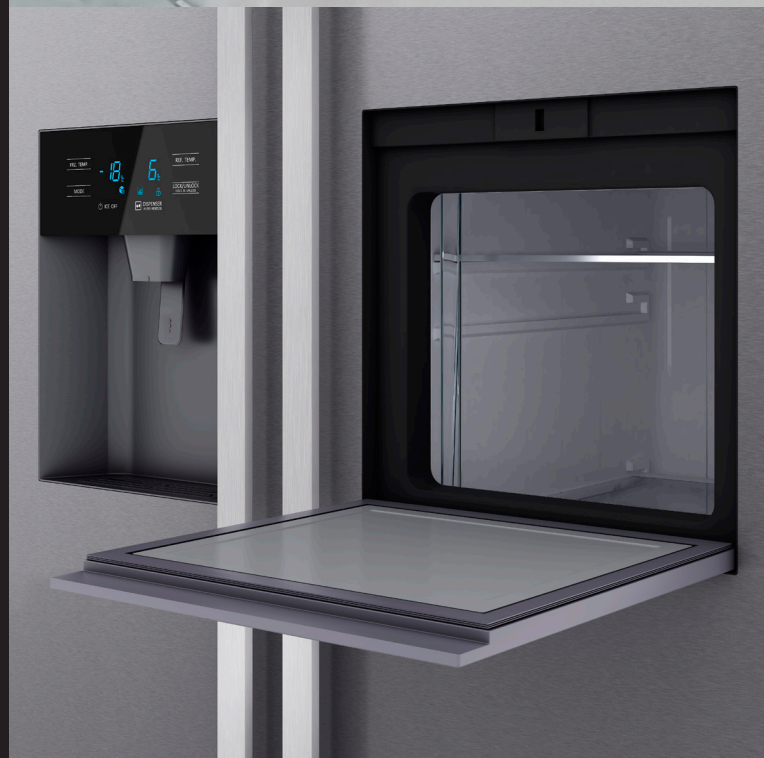





## MAESTRO

Domestic appliances for those who like going one step further. For those who will not settle for being like the rest.

## TOTAL

Designed for those who demand everything of their appliances, for everyone in the house. Maximum effectiveness in any situation.

## EASY

For those who prefer no complications in the kitchen without denying themselves an appliance that gives so much while asking for so little in return.

TOTAL		EASY	
A+++	A++	A++	



NFL 450 S



NFL 430 S



NFL 342 C



NFL 342 C



**NEW**

## MAESTRO RFD 77820

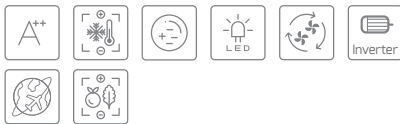

- French Door Gourmet Refrigerator
- Motor inverter with high efficiency compressor
- IonClean technology to neutralize bacteria and bad odours
- LongLife No Frost with 3 independent circuits
- Touch control with independent temperature regulator
- Chromed details
- Gourmet Box with telescopic guides and softclose, interior light, display, and Touch control with independent temperature regulator between -2° and +3°C
- 2 VitaCare Box drawers with independent humidity control
- Top and back LED light
- TempGuard Radar technology
- Interior LED light in freezer
- Pull-out telescopic softclose drawer with deep tray and two special drawers for meat and fish
- Pull-out telescopic softclose deep drawer with an upper tray with telescopic guides
- Removable freezer drawers for easy cleaning

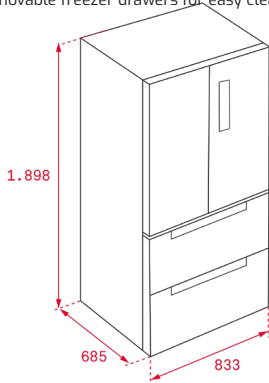

**COLOR**

 Glass Black

**EXTERNAL DIMENSIONS**

Height 1898mm Width 833mm Depth 685mm



**NEW**

## MAESTRO RFD 77820

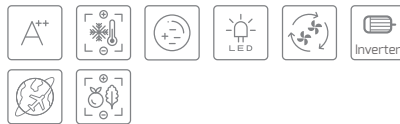

- French Door Gourmet Refrigerator
- Motor inverter with high efficiency compressor
- IonClean technology to neutralize bacteria and bad odours
- LongLife No Frost with 3 independent circuits
- Touch control with independent temperature regulator
- Chromed details
- Gourmet Box with telescopic guides and softclose, interior light, display, and Touch control with independent temperature regulator between -2° and +3°C
- 2 VitaCare Box drawers with independent humidity control
- Top and back LED light
- TempGuard Radar technology
- Interior LED light in freezer
- Pull-out telescopic softclose drawer with deep tray and two special drawers for meat and fish
- Pull-out telescopic softclose deep drawer with an upper tray with telescopic guides
- Removable freezer drawers for easy cleaning

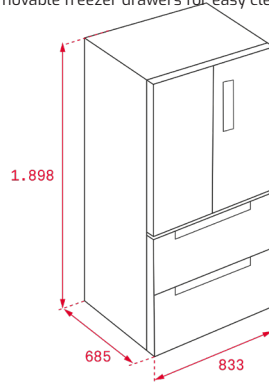

**COLOR**

 Stainless Steel

**EXTERNAL DIMENSIONS**

Height 1898mm Width 833mm Depth 685mm



**NEW**

## MAESTRO RMF 77920



- Motor inverter with high efficiency compressor
- IonClean technology to neutralize bacteria and bad odours
- LongLife No Frost with 3 independent circuits
- Touch control with independent temperature regulator in refrigerator, freezer and Multizone compartment
- Vacation mode / ECO
- Anti-bacterial treatment
- Fast freezing and cooling
- FreshBox drawers
- Twister Ice Maker
- Three safety glass shelves with adjustable height
- Top and back LED light
- Chrome details
- Automatic temperature control system Fuzzy Logic
- Safety lock for children
- Six door adjustable balconies
- Integrated handle

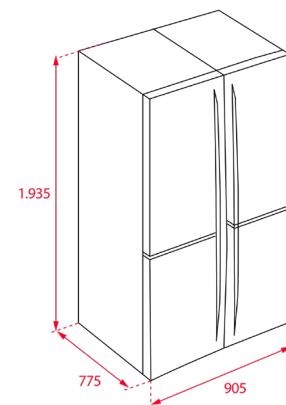

**COLOR**

 Stainless Steel

**EXTERNAL DIMENSIONS**

Height 1935mm Width 905mm Depth 775mm



**NEW**

**MAESTRO RLF 74925**



- No Frost Total cold: refrigerator and freezer
- Electronic display with freezer and refrigerator temperature control and indicator
- Bar on door system
- Vacation mode
- ECO function
- Fast freezing and cooling
- Two FreshBox drawers
- IceMaker: Auto water and ice dispenser with filter system
- Seven safety glass shelves with adjustable height
- Interior LED light in freezer and refrigerator
- Safety lock for children
- Eight door balconies
- External metal handle
- Back wheels to move the appliance easily
- Adjustable front feet

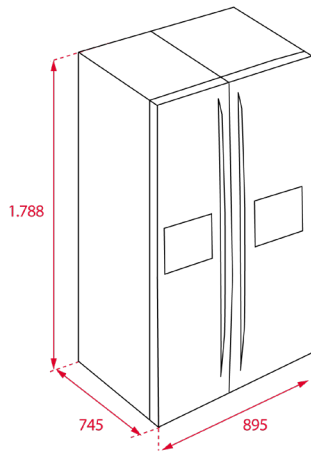

**COLOR**

 **Stainless Steel**

**EXTERNAL DIMENSIONS**

**Height** 1788mm **Width** 895mm **Depth** 745mm



# COLD LINE



**NEW**

## MAESTRO RLF 74920



- No Frost Total cold: refrigerator and freezer
- Electronic display with freezer and refrigerator temperature control and indicator
- Vacation mode
- ECO function
- Fast freezing and cooling
- Two FreshBox drawers
- IceMaker: Auto water and ice dispenser with filter system
- Seven safety glass shelves with adjustable height
- Interior LED light in freezer and refrigerator
- Safety lock for children
- Eight door balconies
- External metal handle
- Back wheels to move the appliance easily
- Adjustable front feet

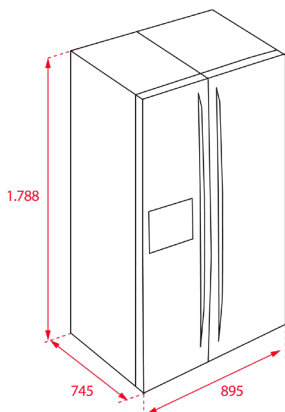

**COLOR**

Stainless Steel

**EXTERNAL DIMENSIONS**

Height 1788mm Width 895mm Depth 745mm



**NEW**

## MAESTRO RLF 74910



- No Frost Total cold: refrigerator and freezer
- Electronic display with freezer and refrigerator temperature control and indicator
- Vacation mode
- ECO function
- Fast freezing and cooling
- Two FreshBox drawers
- Twister Ice Maker
- Eight safety glass shelves with adjustable height
- Interior LED light in freezer and refrigerator
- Safety lock for children
- Ten door balconies
- External metal handle
- Back wheels to move the appliance easily
- Adjustable front feet

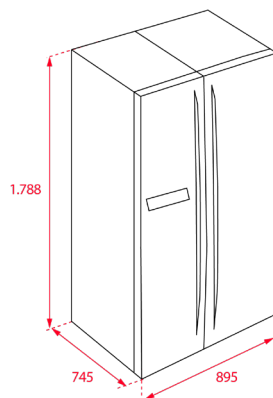

**COLOR**

Stainless Steel

**EXTERNAL DIMENSIONS**

Height 1788mm Width 895mm Depth 745mm



**NEW**

## MAESTRO RLF 74910



- No Frost Total cold: refrigerator and freezer
- Electronic display with freezer and refrigerator temperature control and indicator
- Vacation mode
- ECO function
- Fast freezing and cooling
- Two FreshBox drawers
- Twister Ice Maker
- Eight safety glass shelves with adjustable height
- Interior LED light in freezer and refrigerator
- Safety lock for children
- Ten door balconies
- External metal handle
- Back wheels to move the appliance easily
- Adjustable front feet

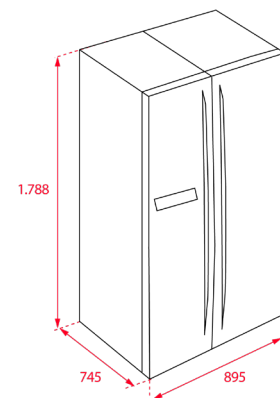

**COLOR**

White

**EXTERNAL DIMENSIONS**

Height 1788mm Width 895mm Depth 745mm



NEW

MAESTRO RBF 78720

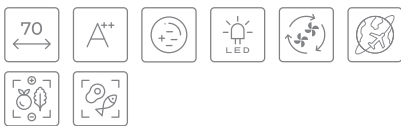

- Urban Colors Edition
- IonClean technology
- LongLife No Frost with 2 independent circuits
- Large capacity (510 litres gross ) 70 cm wide
- Electronic display with refrigerator and freezer temperature control
- Vacation mode / ECO
- Fast freezing and cooling
- ZeroBox drawer
- VitaCare Box drawer with humidity regulator
- Twister Ice Maker
- Four safety glass shelves with adjustable height
- Interior Side LED lights
- Chromed details and bottle rack
- Safety lock for children
- FlexiRack system
- Integrated handle
- Back wheels to move the appliance easily
- Adjustable front feet
- Reversible doors

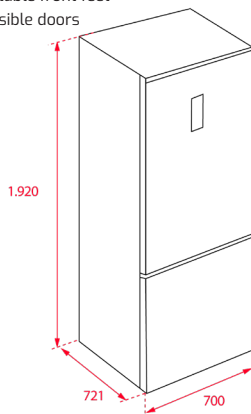

COLOR

Glass Black

EXTERNAL DIMENSIONS

Height 1920mm Width 700mm Depth 721mm



NEW

MAESTRO RBF 78720

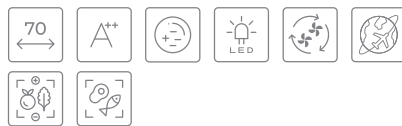

- Urban Colors Edition
- IonClean technology
- LongLife No Frost with 2 independent circuits
- Large capacity (510 litres gross ) 70 cm wide
- Electronic display with refrigerator and freezer temperature control
- Vacation mode / ECO
- Fast freezing and cooling
- ZeroBox drawer
- VitaCare Box drawer with humidity regulator
- Twister Ice Maker
- Four safety glass shelves with adjustable height
- Interior Side LED lights
- Chromed details and bottle rack
- Safety lock for children
- FlexiRack system
- Integrated handle
- Back wheels to move the appliance easily
- Adjustable front feet
- Reversible doors

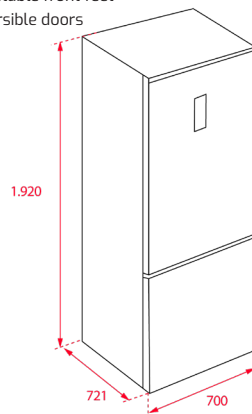

COLOR

Glass White

EXTERNAL DIMENSIONS

Height 1920mm Width 700mm Depth 721mm



NEW

MAESTRO RBF 78720



- IonClean technology
- LongLife No Frost with 2 independent circuits
- Large capacity (510 litres gross ) 70 cm wide
- Electronic display with refrigerator and freezer temperature control
- Vacation mode / ECO
- Fast freezing and cooling
- ZeroBox drawer
- VitaCare Box drawer with humidity regulator
- Twister Ice Maker
- Four safety glass shelves with adjustable height
- Interior Side LED lights
- Chromed details and bottle rack
- Safety lock for children
- FlexiRack system
- Integrated handle
- Back wheels to move the appliance easily
- Adjustable front feet
- Reversible doors

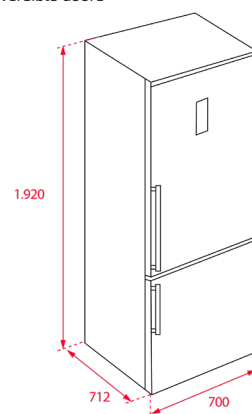

COLOR

Stainless Steel

EXTERNAL DIMENSIONS

Height 1920mm Width 700mm Depth 712mm

# COLD LINE



**NEW**

## MAESTRO RBF 78630

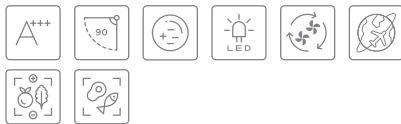

- IonClean technology
- LongLife No Frost with 2 independent circuits
- Electronic display indicator with refrigerator and freezer temperature control
- Vacation mode / ECO
- Fast freezing and cooling
- ZeroBox drawer
- VitaCare Box drawer with humidity regulator
- Four safety glass shelves with adjustable height
- Interior Side LED light
- Chromed details and bottle rack
- Safety lock for children
- Four door balconies / FlexiRack adjustment
- Three drawers in the freezer with glass shelves
- Metal door handles
- Back wheels to move the appliance easily
- Adjustable front feet
- Anti-fingerprint stainless steel reversible doors
- Easy 90° installation

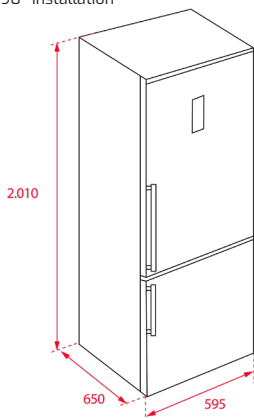

**COLOR**

Stainless Steel

**EXTERNAL DIMENSIONS**

Height 2010mm Width 595mm Depth 650mm



**NEW**

## MAESTRO RBF 74620

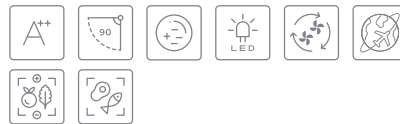

- IonClean technology
- LongLife No Frost with 2 independent circuits
- Electronic display indicator with refrigerator and freezer temperature control
- Vacation mode / ECO
- Fast freezing and cooling
- ZeroBox drawer
- VitaCare Box drawer with humidity regulator
- Four safety glass shelves with adjustable height
- Interior Side LED light
- Chromed details and bottle rack
- Safety lock for children
- Four door balconies / FlexiRack adjustment
- Three drawers in the freezer with glass shelves
- Metal door handles
- Back wheels to move the appliance easily
- Adjustable front feet
- Anti-fingerprint stainless steel reversible doors
- Easy 90° installation

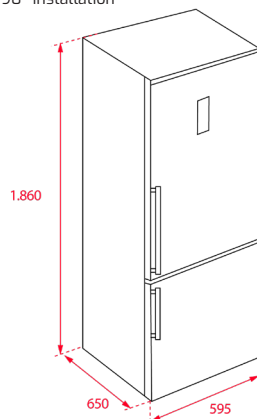

**COLOR**

Stainless Steel

**EXTERNAL DIMENSIONS**

Height 1860mm Width 595mm Depth 650mm



**NEW**

## TOTAL NFL 450 S



- No Frost Total cold: refrigerator and freezer
- Electronic display indicator with refrigerator and freezer temperature control
- Metal cool column
- Vacation mode
- ECO function
- Anti-bacterial treatment
- Fast freezing and cooling
- ZeroBox drawer (21 litres - net)
- FreshBox drawer
- Four safety glass shelves with adjustable height
- Interior LED light
- Chromed details and bottle rack
- Automatic temperature control system Fuzzy Logic
- Safety lock for children
- Three adjustable door balconies
- Three drawers in the freezer with glass shelves
- Integrated handle
- Total accessibility with a 90° open door
- Back wheels to move the appliance easily
- Adjustable front feet
- Anti-fingerprint stainless steel reversible doors

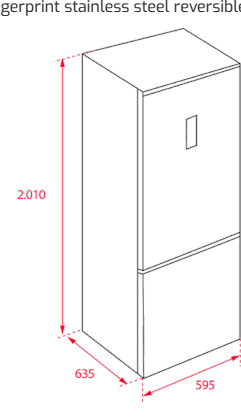

**COLOR**

Stainless Steel

**EXTERNAL DIMENSIONS**

Height 2010mm Width 595mm Depth 635mm



**NEW**

**TOTAL NFL 430 S**



- No Frost Total cold: refrigerator and freezer
- Electronic display with refrigerator temperature indicator
- Fast cooling
- Interior LED light
- Two FreshBox drawers
- Four safety glass shelves with adjustable height
- Chrome bottle rack
- Six adjustable door balconies
- Three drawers in the freezer with glass shelves
- Integrated handle
- Back wheels to move the appliance easily
- Adjustable front feet
- Reversible doors

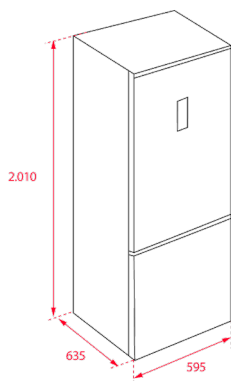

**COLOR**  
 White

**EXTERNAL DIMENSIONS**  
 Height 2010mm Width 595mm Depth 635mm



**NEW**

**EASY NFL 342 C**



- No Frost Total cold: refrigerator and freezer
- Inner electronic control
- Fast freezing and cooling
- 2 FreshBox drawers
- Three safety glass shelves
- Interior LED light
- Five transparent door balconies
- Three drawers in the freezer with glass shelves
- Integrated handle
- Back wheels to move the appliance easily
- Adjustable front feet
- Anti-fingerprint stainless steel reversible doors

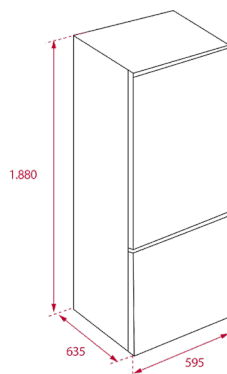

**COLOR**  
 Stainless Steel

**EXTERNAL DIMENSIONS**  
 Height 1880mm Width 595mm Depth 635mm



**NEW**

**EASY NFL 342 C**



- No Frost Total cold: refrigerator and freezer
- Inner electronic control
- Fast freezing and cooling
- FreshBox drawer
- Three safety glass shelves
- Interior LED light
- Five transparent door balconies
- Three drawers in the freezer with glass shelves
- Integrated handle
- Back wheels to move the appliance easily
- Adjustable front feet
- Anti-fingerprint stainless steel reversible doors

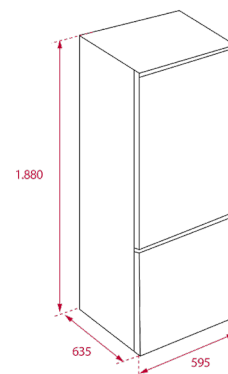

**COLOR**  
 White

**EXTERNAL DIMENSIONS**  
 Height 1880mm Width 595mm Depth 635mm



# COLD LINE

Modelo	RFD 77820	RMF 77920	RLF 74925	RLF 74920	RLF 74910	RBF 78720
<b>PRODUCT FICHE</b>						
Category	7	7	7	7	7	7
Energy efficiency class (1)	A++	A++	A++	A++	A+	A++
Annual consumption (KWh/year) (2)	333	380	322	322	405	321
Total Gross Capacity (litres)	537	648	574	573	587	510
Refrigerator compartment capacity (litres)	304	455	334	334	339	333
Chilling compartment capacity (litres)	31	NA	NA	NA	NA	24
Freezer compartment capacity (litres)	165	182	156	156	171	128
Freezer clasification (stars)	4	4	4	4	4	4
No frost in refrigeration compartment	✓	✓	✓	✓	✓	✓
No frost in chiller	✓	✓	✓	✓	-	✓
No frost in freezer compartment	✓	✓	✓	✓	✓	✓
Temperature rise time (autonomy) (3)	15	16	7	7	10	24
Freezing Capacity (Kg/24h)	13	15	14	14	9	9
Climate class	T	N/T	N/T	N/T	N/T	SN/T
Noise level (dB)	42	43	43	43	43	43
Type of installation	Free Standing	Free Standing	Free Standing	Free Standing	Free Standing	Free Standing
<b>ELECTRICAL FEATURES</b>						
Power Rate (W)	260	175	188	188	130	206
Defrost element power (W)	250	262	240	240	240	185
Energy consumption (Kw/day)	0.92	1.04	0.88	0.88	1.11	0.88

Modelo	RBF 78630	RBF 74620	NFL 450 S	NFL 430 S	NFL 342 C
<b>PRODUCT FICHE</b>					
Category	7	7	7	7	7
Energy efficiency class (1)	A+++	A++	A+++	A++	A++
Annual consumption (KWh/year) (2)	182	263	167	234	224
Total Gross Capacity (litres)	379	341	350	360	308
Refrigerator compartment capacity (litres)	266	230	219	250	219
Chilling compartment capacity (litres)	22	22	21	NA	NA
Freezer compartment capacity (litres)	94	94	76	76	76
Freezer clasification (stars)	4	4	4	4	4
No frost in refrigeration compartment	✓	✓	✓	✓	✓
No frost in chiller	✓	✓	✓	-	-
No frost in freezer compartment	✓	✓	✓	✓	✓
Temperature rise time (autonomy) (3)	18	18	15	15	15
Freezing Capacity (Kg/24h)	8	8	8.5	4	4
Climate class	SN/T	SN/T	N/T	N/T	N/T
Noise level (dB)	42	42	40	40	40
Type of installation	Free Standing	Free Standing	Free Standing	Free Standing	Free Standing
<b>ELECTRICAL FEATURES</b>					
Power Rate (W)	162	197	150	150	170
Defrost element power (W)	145	145	190	160	175
Energy consumption (Kw/day)	0.50	0.72	0.46	0.65	0.61

(1) Energy efficiency class "X" on a scale from G (least efficiency) to A+++ (most efficiency)

(2) Energy consumption "XYZ" kWh per year, based on standard test results for 24 hours. Actual energy consumption will depend on how the appliance is used and where it is located.

(3) Temperature rise time