



Life is the sum of these
moments that **surprise us**



LAUNDRY

Technology and **design** combined for your day to day

Feel the soft and smooth touch of your clothes on the skin and enjoy the fresh smell of your laundry. Teka washing machines take the best care of your clothes and bring a unique aroma to your whole home. The smell of freshness you still can remember from every Sunday morning when you were a child. The feeling of wearing brand new clothes that were just washed for the very first time and make you feel better, protected and comfortable to face a new day. Imagine to get such a feeling every time you do your laundry .

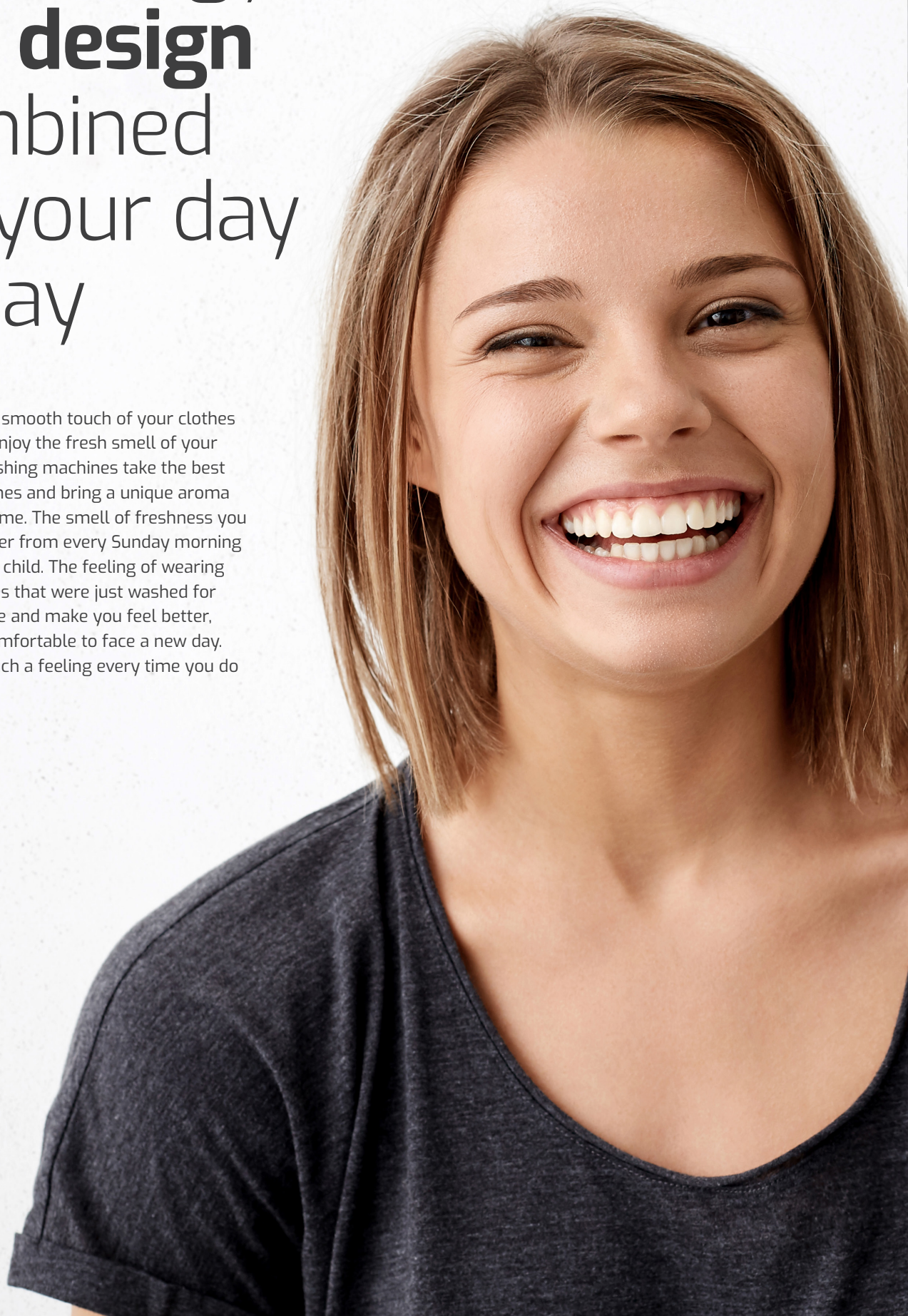



SoftCare Drumb

The easiest way to break water resistance. Taking care of clothes in every washing, keeping the texture of your clothes and softness. The innovating Softcare design of the drum, made of dozens of small cubes, improves the gentle care wqvof your laundry during washing, drying and spinning. Woolmark certificate is

an universal quality seal to demonstrate our washers keep your clothes with most of the softness, even after many washings. Feel the freedom of washing your most delicate wool clothes.

A+++

Consumption and a lot to offer. New Inverter engines generation have less vibrations and noise and have improved durability, with an A+++ energy classification, a remarkable saving.





Find a wide range of options with the union kit ready to combine all the benefits of the spa washers with the last drying technology

Heat pump dryer works with less temperature than ordinary dryers, for a gentle care of your laundry. There is no need to reach high temperatures to be efficient and you also save energy: good for you, good for environment.

The union kit can be used with several vertical models to take advantage of the room space. It has a removable tray to fold clothes up to 16kg and help you out to keep order at home.



More capacity

For those who needs more than ordinary capacity, like big families, large clothes, curtains or rugs. Teka has a wide range of washing machines ready for you. The new washer and dryer can wash 10 kg, and the dry up to 7 kg. Everything in just one appliance with many features, designed to bring harmony to your home.

My cycle

We know each people has different needs. With "my cycle" you can choose your favourite program, changing types of clothes, temperatures, speed, etc. The washing machine memorize them and it's done! Find the right program in the control display and feel like this appliance was designed just for you. Because we do know everyone is unique and deserves appliances designed just for them.







Delay programming

We don't spend as much time at home as we would like to, so we need a little helper at houseworking. You can program Teka washers from 1 to 24 hours. Your laundry will be clean when you come back home from work or, if you have a night electricity plan, you can even program the washing machine during night to reduce consumption.



Laundry

Minimum consumption, highly accurate and very easy to use.

MAESTRO							
WASHERS				DRYERS			
R.P.M.	9 KG	8 KG	7 KG	8 KG			
FREE STANDING	1400	 TKD 1490	 SPA TKD 1480	 SPA TKD 1480			
	1200	 SPA TKD 1280		 SPA TKD 1270	 SPA TKD 1270		
	1000						
						 SPA TK5 893 H	

MAESTRO

Domestic appliances for those who like going one step further. For those who will not settle for being like the rest.

TOTAL

Designed for those who demand everything of their appliances, for everyone in the house. Maximum effectiveness in any situation.

EASY

For those who prefer no complications in the kitchen without denying themselves an appliance that gives so much while asking for so little in return.

EASY

WASHERS

6 KG



TKX3 1263

LAUNDRY

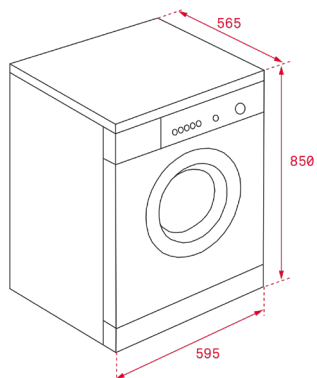

MAESTRO TKD 1490



- Free standing washing machine
- Washing capacity: 9 Kg
- Inverter Motor
- Washing Programs: 16
- Electronic control panel
- Digital display LCD
- Maximum spin speed : 1400 rpm
- Electronic washing management (Fuzzy Logic)
- Special Programs Wool, baby care and 15'
- Fast program 15 minutes
- 32 cm wide crystal door
- Function buttons for: temperature, spinning speed, remaining time and special functions
- Automatic water regulation
- Delay timer 1-24h
- Balance control system
- Locking system in case of lack of water or electricity
- Foam control system
- Energy class: A+++/B
- Energy consumption: 175 kWh/year
- Water consumption: 10.000 liters/year

COLOR

White

EXTERNAL DIMENSIONS

Height 850mm Width 595mm Depth 565mm





MAESTRO SPA TKD 1480



- Free standing washing machine
- Washing capacity: 8 Kg
- 16 washing programs
- Woolmark® certification
- Maximum spin speed: 1400 r.p.m
- Electronic control panel
- LCD display
- Electronic washing management (Fuzzy Logic)
- Fast program 15 minutes
- My Cycle program
- Special programs: wool, children's clothing and 15'
- Delay timer 1-24h
- Balance control system
- Locking system in case of lack of water or electricity
- Foam control system
- 32 cm wide porthole
- Function buttons for: on/off, program selector, delay programming, temperature, spinning exclusion and special functions
- Energy class: A+++/B

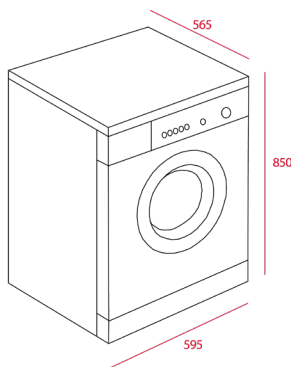

COLOR
 Stainless Steel

EXTERNAL DIMENSIONS
 Height 850mm Width 595mm Depth 565mm

MAESTRO SPA TKD 1480



- Free standing washing machine
- Washing capacity: 8 Kg
- 16 washing programs
- Woolmark® certification
- Maximum spin speed: 1400 r.p.m
- Electronic control panel
- LCD display
- Electronic washing management (Fuzzy Logic)
- Fast program 15 minutes
- My Cycle program
- Special programs: wool, children's clothing and 15'
- Delay timer 1-24h
- Balance control system
- Locking system in case of lack of water or electricity
- Foam control system
- 32 cm wide porthole
- Function buttons for: on/off, program selector, delay programming, temperature, spinning exclusion and special functions
- Energy class: A+++/B

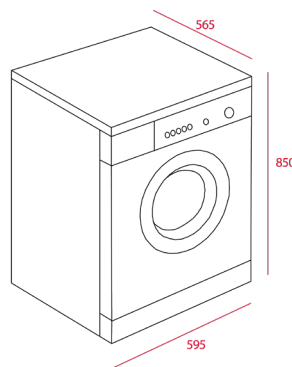

COLOR
 White

EXTERNAL DIMENSIONS
 Height 850mm Width 595mm Depth 565mm

MAESTRO SPA TKD 1280



- Free standing washing machine
- Washing capacity: 8 Kg
- 16 washing programs
- Woolmark® certification
- Maximum spin speed: 1200 r.p.m
- Electronic control panel
- LCD display
- Electronic washing management (Fuzzy Logic)
- Fast program 15 minutes
- My Cycle program
- Special programs: wool, children's clothing and 15'
- Delay timer 1-24h
- Balance control system
- Locking system in case of lack of water or electricity
- Foam control system 32 cm wide porthole
- Function buttons for: on/off, program selector, delay programming, temperature, spinning exclusion and special functions
- Energy class: A+++/B

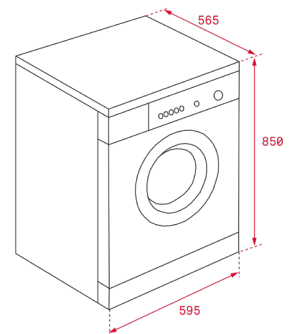

COLOR
 White

EXTERNAL DIMENSIONS
 Height 850mm Width 595mm Depth 565mm



MAESTRO SPA TKD 1270



- Free standing washing machine
- Washing capacity: 7 Kg
- 16 washing programs
- Maximum spin speed: 1200 r.p.m
- Electronic control panel
- LCD display
- Electronic washing management (Fuzzy Logic)
- Fast program 15 minutes
- My Cycle program
- Special programs: wool, children's clothing and 15'
- Delay timer 1-24h
- Balance control system
- Locking system in case of lack of water or electricity
- Foam control system
- 32 cm wide porthole
- Function buttons for: on/off, program selector, delay programming, temperature, spinning exclusion and special functions
- Energy class: A+++/B

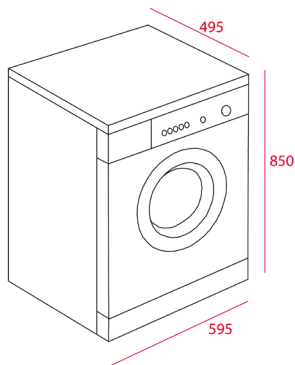

COLOR
 Stainless Steel

EXTERNAL DIMENSIONS
 Height 850mm Width 595mm Depth 495mm



MAESTRO SPA TKD 1270



- Free standing washing machine
- Washing capacity: 7 Kg
- 16 washing programs
- Maximum spin speed: 1200 r.p.m
- Electronic control panel
- LCD display
- Electronic washing management (Fuzzy Logic)
- Fast program 15 minutes
- My Cycle program
- Special programs: wool, children's clothing and 15'
- Delay timer 1-24h
- Balance control system
- Locking system in case of lack of water or electricity
- Foam control system
- 32 cm wide porthole
- Function buttons for: on/off, program selector, delay programming, temperature, spinning exclusion and special functions
- Energy class: A+++/B

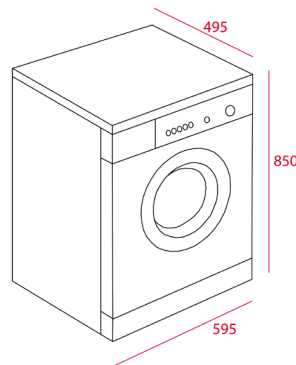

COLOR
 White

EXTERNAL DIMENSIONS
 Height 850mm Width 595mm Depth 495mm



NEW

EASY TKX3 1263



- Free standing washing machine
- Washing capacity: 6 kg
- Spin selector: 1200 ~ 400 rpm
- 16 programs
- My Cycle program
- Special programs: children's clothing and 15'
- 15' fast program
- Control functions: on-off, temperature, spinning selector, delay start
- Delay timer: 1-24 hours.

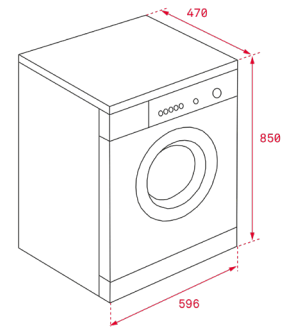

COLOR
 White

EXTERNAL DIMENSIONS
 Height 850mm Width 595mm Depth 470mm



NEW

MAESTRO SPA TKS 893 H



- Free standing Dryer
- Heat pump condenser dryer
- Drying capacity: 8 kg
- 16 programs
- Electronic control with digital display
- Humidity sensor
- Stainless steel drum
- 4 power levels
- LED indicators for: on/off, filter saturation, and full tank
- Bi-direction rotation
- Delay timer: 1-24h

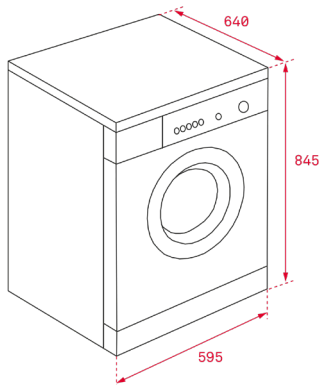

COLOR



White

EXTERNAL DIMENSIONS

Height 845mm Width 595mm Depth 640mm



LAUNDRY

Modelo	TKD 1490	SPA TKD 1480	SPA TKD 1280	SPA TKD 1270	TKX3 1263	SPA TKS 893 H
PRODUCT FICHE						
Washing capacity (Kgs)	9	8	8	7	6	-
Energy Efficiency Class (1)	A+++	A+++	A+++	A+++	A+++	A+++
Energy consumption per year (kWh) (2)	218	196	196	175	153	176
Consumption / cycle energy (kWh) (3)	0,93/0,80/0,51	1,05/ 0,84/0,63	1,05/ 0,84/0,63	0,93/0,80/0,51	0,72/0,69/0,60	-
Power consumption in off-mode and left-on mode	0,50/1,00	0,50/1,00	0,50/1,00	0,50/1,00	0,50/1,00	0,20/0,80
Water consumption (litre/year) (4)	14.000	11.000	11.000	10.000	9.240	-
Spinning efficiency	B	B	B	B	B	-
Maximum spinning speed	1.400	1.400	1.200	1.200	1.200	-
Percentage of water after the spinning	53	53	53	53	61	-
Cycle duration (minutes) (3)	179/179/179	179/179/179	179/179/179	179/179/179	222/211/203	-
Noise level dB washing/spinning	54/76	59/78	59/76	59/76	59/76	-
Drying capacity (Kgs)	-	-	-	-	-	8
Drying technology	-	-	-	-	-	Condenser heat pump
Automatic (sensor drying)	-	-	-	-	-	√
Energy cycle consumption full/partial load (kWh)	0,93/0,80/0,51	-	-	-	-	1,50/0,79
Program duration Tt, T1, T 1/2 (minutes) (3)	179/179/179	179/179/179	179/179/179	179/179/179	-	144/190/110
Condensation efficiency (4)	-	-	-	-	-	B
Condensation percentages C1, C 1/2, Ct (5)	-	-	-	-	-	80,5/80,5/80,5
Noise level (dBA)	-	-	-	-	-	65
Energy consumption for washing, spinning and drying, kWh (2)	-	-	-	-	-	-
Washing performance class (1)	-	-	-	-	-	-
Water remaining after spinning in % (as a proportion of dry weight of wash)	-	-	-	-	-	-
Water consumption for washing, spinning and drying, l (4)	-	-	-	-	-	-
Water consumption for washing and spinning, l (5)	-	-	-	-	-	-
Energy consumption, never using the dryer (kWh/year) (7)	-	-	-	-	-	-
Water consumption, never using the dryer (l/year) (7)	-	-	-	-	-	-
ELECTRICAL FEATURES						
Maximum Nominal Power (W)	2.050	2.000	2.000	2.050	2.100	650
Nominal Power motor (W)	500	500	500	450	450	120
Nominal Power heating element (W)	1.800	1.800	1.800	1.800	1.800	-