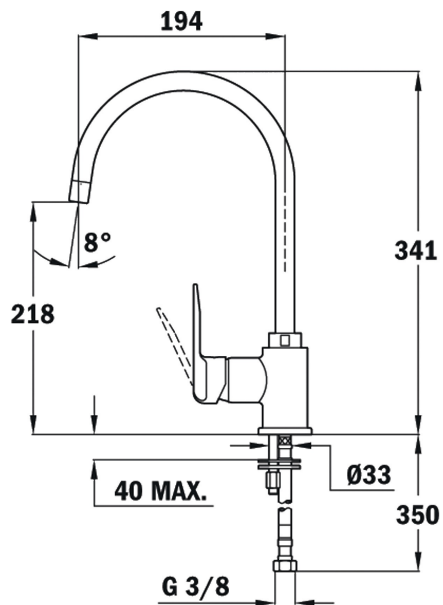

Anti-Scale
AeratorSwivel
Spout

REFERENCE

REF: 55995020CN

EAN: 8421152134740

FEATURES

High spout kitchen tap

Swivel spout

Anti-scale aerator

Cartridge with ceramic discs of high resistance

Highly precise temperature control







Greater handling sensitivity with smoother movements

3/8" flexible inlet pipes

DIMENSIONS

Product height (mm): 341**Product width (mm):****Product depth (mm):****Product length (mm):****Net weight (Kg):** 1,55

COLOURS

	55995020CN	Carbon
	559950200	Topasbeige
	559950200	Sandbeige
	559950200	Metallic Black
	559950200	Stainless Steel
	559950200	Chrome