



EWH 50 H Water heater with double installation system and 50L capacity



Dry Heating Protection



ELCB Earth Leakage Circuit Breaker



Humidity Control



Overheating Protection



Type of Installation

DESCRIPTION

Water heater with double installation system and 50L capacity

LIFE STYLE

Total

COLOURS



REFERENCE

REF. 42080250
EAN. 8421152131954



TEKA

EWH 50 H

FEATURES

Vertical and horizontal installation
Capacity: 50 litres
Sapphire enamelled tank
Sapphire heating element
Regulation of temperature: 30-75 °C
Pressure valve > 5 bar
Max. Input temperature: 0,75Mpa
Thermometer
Anti Over-pressure protection
Earth leakage circuit breaker ELCB
Overheat protection
Anti Dry-heating Protection
Waterproof Grade: IPX4
Rated power output 1500 W
Thickness of insulation: 20mm
Water connection: G½
Average number of users: 2-3

DIMENSIONS

Product height (mm): 711

Product width (mm): 385

Product depth (mm): 385

Product length (mm):

Net weight (Kg): 18,3

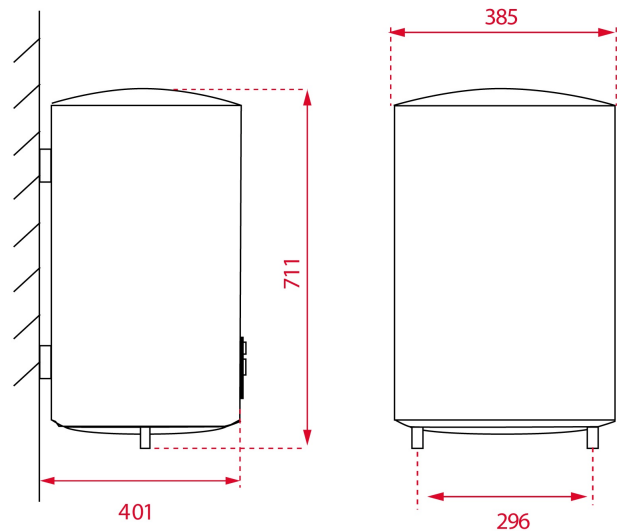

TECH SPECS

PARTICULAR CHARACTERISTICS

Power rate (V): 220-240

Frequency (Hz): 50

Power rate (W): 1.500

Plug type: EU

Type of installation: Vertical, Horizontal

Certificates: CE; CB

Average number of users: 2-3

Control panel: MECHANICAL

Number of power levels: 1

Maximum input pressure (Mpa): 0,75

Sapphire Enamelled Steel Tank: Yes

Magnesium protection anode: Yes

Heating element indicator lamp: Yes

Thermometer: Yes

Insulation thickness (mm): 20,00

Degree of protection against humidity: IPX4

Protection against heating: Yes

Dry heating protection: Yes

EU REGULATION NO.
812/2013

Declared load profile: M

Water heating energy efficiency class: C

Annual energy consumption AEC kWh/annum (kWh): 1418,00

Sound power level L WA (dB): 15

**EU REGULATION NO.
814/2013**

Storage Volume V L (L): 46



EWH 50 H

ENERGY LABEL

