



NFB 320 Full No Frost Combi refrigerator 188cm with 2 doors and electronic control panel



Fresh Box



Full No Frost



Zero Box

DESCRIPTION

Full No Frost Combi refrigerator 188cm with 2 doors and electronic control panel

LIFE STYLE

Easy

COLOURS



REFERENCE

REF. 40698090
EAN. 8421152119570



TEKA

NFB 320

FEATURES

Full No Frost Combi refrigerator
Electronic control panel
Stainless steel finishing
4 * freezer
Antibacterial gasket
Safety glass shelves
0-3° Zone
2 vegetable drawers
Climate Class : SN-T
Noise level : 43 dBA
Total gross capacity : 320 litres
Net capacity (fridge): 172 litres
Net capacity (chiller): 25 litres
Net capacity (freezer): 90 litres
Voltage : 220/40-50 Hz

DIMENSIONS

Product height (mm): 1853
Product width (mm): 595
Product depth (mm): 600
Product length (mm):
Net weight (Kg): 64

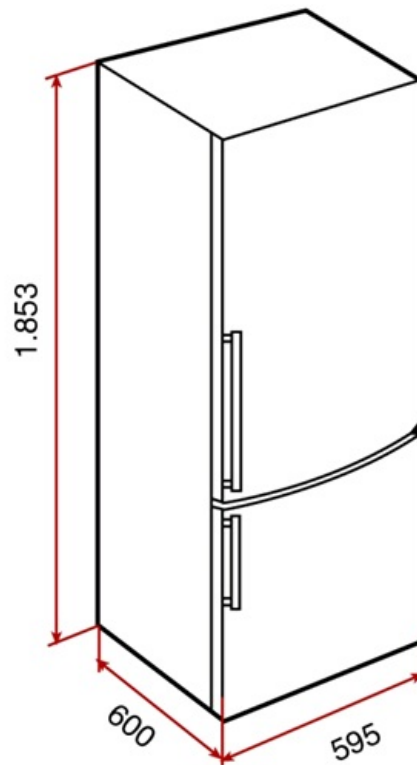

TECH SPECS

PRODUCT SHEET

Cooling system: FULL NF
No Frost In Refrigerator Compartment: Yes
No Frost in freezer compartment: Yes
Total gross capacity (litres): 320
Refrigerator compartment capacity (litres): 172
Chilling Compartment Capacity (litres): 25
Freezer compartment capacity (litres): 90
Freezer classification: 4
Freezing capacity: 4,0
Annual Consumption (kWh/year): 333
Temperature Rise Time (h): 17
Climate class: SN/T
Noise level (dB): 43
Certificates: CE, TUV

POWER SUPPLY

Frequency (Hz): 50
Power rate (V): 230
Power rate (W): 120
Defrost element power (W): 127
Energy consumption (kw/day): 0,913

**PARTICULAR
CHARACTERISTICS**

Type of installation: Free standing
Automatic defrosting in the refrigeration compartment: Yes
Automatic defrosting in the freezer compartment: Yes
Antibacterial treatment: NO
Inner light: Yes
Type of inner light: STANDARD BULB
Reversible doors: Yes
External handle: Yes

EQUIPMENT

Antibacterial gasket: Yes
Multipurpose compartment: NO
Ice cubes tray: 1
Bottle rack type: NO
Adjustable feet front: Yes
Roller (rear): Yes
Refrigerator adjustable shelves: Yes
Vegetable drawers: 2
Temperature and humidity regulation in drawers: FRESH BOX

**PRODUCT INFORMATION
SHEET (UE) 2019/2016**

Supplier name or trademark: TEKA
Supplier's address: C/Cajo, 17, 39011, Santander , Spain
Model identifier: NFB 320

Type of refrigerating appliance

Overall dimensions (mm)

Height: 1853
Width: 595
Depth: 600
Climate class: SN/T

Light source parameters

Light source parameters

Additional information:

Weblink to the manufacturer's website, where the information in point 4(a) Annex of Commission Regulation (EU) 2019/2019 (1) (b) is found:
(a) as determined in accordance with Commission Delegated Regulation (EU) 2019/2015 (2).
(b) changes to these items shall not be considered relevant for the purposes of point 4 of Article 4 of Regulation (EU) 2017/1369.
(c) if the product database automatically generates the definitive content of this cell the supplier shall not enter these data.

(1) Commission Regulation (EU) 2019/2019 of 1 October 2019 laying down ecodesign requirements for refrigerating appliances pursuant to Directive 2009/125/EC of the European Parliament and of the Council and repealing Commission Regulation (EC) No 643/2009 (see page 187 of this Official Journal).(2)

(2) Commission Delegated Regulation (EU) 2019/2015 of 11 March 2019 supplementing Regulation (EU) 2017/1369 of the European Parliament and of the Council with regard to energy labelling of light sources and repealing Commission Delegated Regulation (EU) No 874/2012 (see page 68 of this Official Journal).

