



DLV 685 60cm Vertical Hood with Countour Rim system extraction



LED



Perimeter extraction



Stop Delay
Timer

DESCRIPTION

60cm Vertical Hood with Countour Rim system extraction

LIFE STYLE

Maestro

COLOURS



REFERENCE

REF. 112930009
EAN. 8434778009576

FEATURES

Urban Colors Edition
Quadro vertical hood
Extraction rim system "Contour"
Digital control Touch Control with white display
3 speeds + Intensive
Stop delay timer
LED light bar
Saturation filters lighting indicator
Double turbine motor ECOPOWER
Exhaust capacity (*): min.325 m³/h - max.782 m³/h
Sound level (*): min.54 dBA - máx.65 dBA
Recirculation function optional (SET D10CTP)

DIMENSIONS

Product height (mm): 800-1200
Product width (mm): 600
Product depth (mm): 450
Product length (mm):
Net weight (Kg):

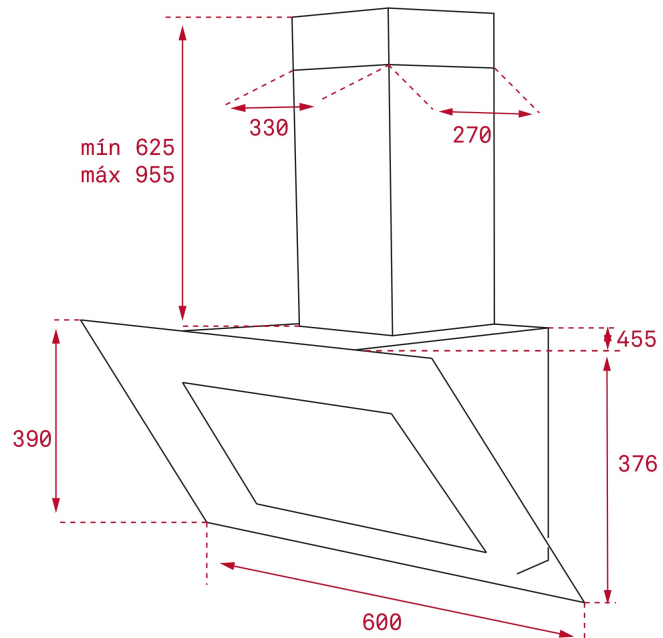

TECH SPECS

PARTICULAR CHARACTERISTICS

Type of hood: Vertical
Style: Decoratives
Certificates: CE; CB; Rohs
Ø Outlet (mm): 150
Type of inner light: LED
Inside light Consumption (W): 7
Plug type: Schuko plug
Power rate (V): 230
Frequency (Hz): 50
Total hood power (W): 287
Number of motors: 1
Motor power (W): 280
Exhaust Capacity - Free Outlet (m³/h): 814

**EU REGULATION NO. 65/2014
 &66/2104**

Annual energy consumption AEC kWh/annum (kWh): 55,5
Energy Efficiency Class: A
Fluid Dynamic Efficiency (FDEhood): 34,5
Fluid Dynamic Efficiency class: A
Light Efficiency (Lehood) lux/Watt: 41,7
Lighting Efficiency class: A

Grease Filtering Efficiency class: G
Air flow (Qmin) m3/h: 325
Air flow (Qmax): 614
Air flow (Qboost): 782
Noise (LwA) Min Speed (dB): 54
Noise (LwA) Max Speed (dB): 65
Noise (LwA) boost speed (dB): 72
Off mode Power (Po) W: 0,32
Energy Efficiency Index (EEI): 50,5
Time increase factor: 0,8
Electric power input at best efficiency point (Wbep) W: 160,0
Nominal power of the lighting system (WL) W: 12
Average illumination of the lighting system on the cooking surface (Emiddle) Lux: 500

ACCESSORIES

Anti Return valve: Yes
Outlet reduction: Yes
Optional Charcoal Filter: D4C
Charcoal filter description: CHARCOAL FILTER D4C
Conventional recirculation kit (with tube cover): 40490147

MODELS

Number of filters: 1
Filter description: Glass panel; aluminum filter below
Control panel: Touch control white display
Stop delay timer: Yes
Filter saturation indicator: Yes
Time clock: Yes
Number of speeds: 3+1

PRODUCT INFORMATION SHEET - DELEGATED REGULATION (EU) 65/2014

Supplier name or trademark: TEKA
Model identifier: DLV 685
Annual Energy Consumption: 55,5
Energy Efficiency Class: A
Fluid Dynamic Efficiency: 34,5
Fluid Dynamic Efficiency class: A
Lighting Efficiency: 41,7
Lighting Efficiency class: A
Grease Filtering Efficiency class: G
Air flow (min speed normal use): 325
Air flow (max speed normal use): 614
Air flow (intensive or boost use): 782
Airborne acoustical A-weighted sound power emissions (min speed normal use): 54
Airborne acoustical A-weighted sound power emissions (max speed normal use): 68
Airborne acoustical A-weighted sound power emissions (intensive or boost use): 72
Power consumption in off mode (W): 0,32
Power consumption in standby mode (W): n.a

