



# IZC 63632 MST 60cm Induction Hob with Direct Functions MultiSlider and 3 cooking zones



MultiSlider



Autolock



Power



Power Plus



Easy  
installation



Super Zone

**DESCRIPTION**

60cm Induction Hob with Direct Functions MultiSlider and 3 cooking zones

**LIFE STYLE**

Maestro

**COLOURS**



**REFERENCE**

REF. 112500016  
EAN. 8434778011562



TEKA

IZC 63632 MST

## FEATURES

Urban colors Edition  
Induction hob  
Touch control MultiSlider  
Cooking timer  
3 cooking zones:  
1 induction Ø 320/180 mm  
1 induction Ø 215 mm  
1 induction Ø 150 mm  
Special cooking functions with temperature sensors: Grilling, Deep frying, Pan frying, KeepWarm, Boiling, Simmering, Poach & Melting  
Power Plus function  
Stop & Go function  
Residual heat indicators  
Fast-Click easy installation  
Maximum nominal power : 8.200 W

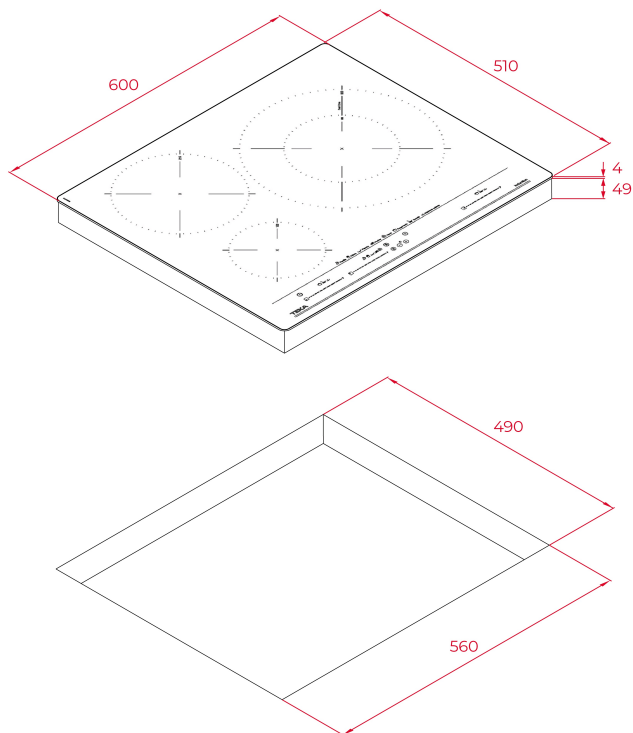

## DIMENSIONS

**Product height (mm):** 53  
**Product width (mm):** 600  
**Product depth (mm):** 510  
**Product length (mm):**  
**Net weight (Kg):** 10,7

## TECH SPECS

### FITTING MEASURES

**Built-in Width (mm):** 560  
**Built-in Depth (mm):** 490  
**Built-in Height (mm):** 49

### PARTICULAR CHARACTERISTICS

**Number of electric power levels:** 9  
**Grilling:** Yes  
**Pan frying:** Yes  
**Deep frying:** Yes  
**Quick Boiling:** Yes  
**Simmering:** Yes  
**Melting:** Yes  
**Keeping warm:** Yes  
**Poach:** Yes  
**Power management function:** Yes

### ELECTRIC CONNECTION

**Frequency (Hz):** 50/60  
**Power rate (V):** 220-240  
**Cable Connection Length (cm):** 110  
**Maximum Nominal Power (W) (Electric hob):** 7200

## **COOKING ZONES**

**Cooking Zones:** 3

**Left rear cooking zone - Diameter (mm):** 215

**Left rear cooking zone - Type:** Single Zone

**Left front cooking zone - Diameter (mm):** 150

**Left front cooking zone - Type:** Single Zone

**Right center cooking zone - Diameter (mm):** 320/180

**Right center cooking zone - Type:** Double Zone

## **SECURITY SYSTEM**

**Residual heat indicator (Gas):** Yes

**Residual heat indicator (Electric hob):** Yes

**Automatic safety disconnection (Auto Lock) (Electric hob):** Yes

**Child lock:** Yes

## **FINISH**

**Surface finishing:** Front bevelled glass

**Surface type:** Ceramic Glass (4mm)

**Easy installation system:** Yes

## **ACCESSORIES**

**Junction Kit:** Optional

**Teppan Yaki:** Optional

