



DBB 90 90cm wall-mounted Pyramid-shaped Extractor Hood



LED lighting

DESCRIPTION

90cm wall-mounted Pyramid-shaped Extractor Hood

LIFE STYLE

Easy

COLOURS



REFERENCE

REF. 40460442
EAN. 8421152069684



TEKA

DBB 90

FEATURES

Pyramidal decorative hood
Push buttons control panel
Operating Pilot Light
Conventional aspiration
3 speeds
Exhaust capacities:
Free Outlet (m³/h): 850
Max. (m³/h): 780
Min. (m³/h): 240
Noise (LwA) Max Speed 56 dB
Noise (LwA) Min Speed 48 dB
Incandescent Lamps
3 aluminum filters

DIMENSIONS

Product height (mm): 749-1049
Product width (mm): 900
Product depth (mm): 480
Product length (mm):
Net weight (Kg): 9,5

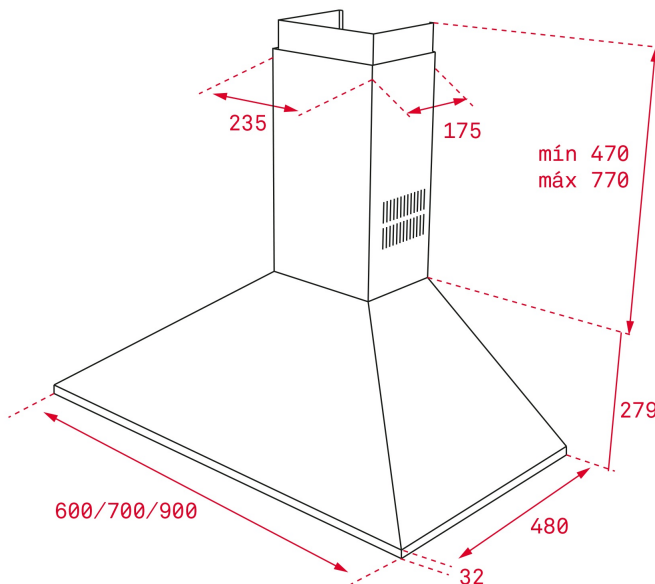

TECH SPECS

PARTICULAR CHARACTERISTICS

Type of hood: Pyramidal
Style: Decoratives
Certificates: CE; CB
Ø Outlet (mm): 150
Type of inner light: LED
Inside light Consumption (W): 5
Plug type: European plug
Power rate (V): 220/240
Frequency (Hz): 50/60
Total hood power (W): 115
Number of motors: 1
Motor power (W): 105
Exhaust Capacity - Free Outlet (m³/h): 475

**EU REGULATION NO. 65/2014
&66/2104**

Annual energy consumption AEC kWh/annum (kWh): 62,3
Energy Efficiency Class: D
Fluid Dynamic Efficiency (FDEhood): 6,9
Fluid Dynamic Efficiency class: F
Light Efficiency (Lehood) lux/Watt: 5,9
Lighting Efficiency class: F

Grease Filtering Efficiency class: D
Air flow (Qmin) m3/h: 234
Air flow (Qmax): 380
Air flow (Qboost): 0
Noise (LwA) Min Speed (dB): 44
Noise (LwA) Max Speed (dB): 60
Noise (LwA) boost speed (dB): 0
Off mode Power (Po) W: 0,00
Standby Power (Ps) W: 0,00
Energy Efficiency Index (EEI): 93,3
Time increase factor: 1,8
Electric power input at best efficiency point (Wbep) W: 83,7
Nominal power of the lighting system (WL) W: 10
Average illumination of the lighting system on the cooking surface (Emiddle) Lux: 59

ACCESSORIES

Anti Return valve: Yes
Outlet reduction: Yes
Optional Charcoal Filter: D4C
Charcoal filter description: CHARCOAL FILTER D4C
Conventional recirculation kit (with tube cover): 40490146

MODELS

Number of filters: 3
Filter description: Aluminum
Control panel: Rectangular Push Buttons
Number of speeds: 3

PRODUCT INFORMATION SHEET - DELEGATED REGULATION (EU) 65/2014

Supplier name or trademark: TEKA
Model identifier: DBB 90
Annual Energy Consumption: 62,3
Energy Efficiency Class: D
Fluid Dynamic Efficiency: 6,9
Fluid Dynamic Efficiency class: F
Lighting Efficiency: 5,9
Lighting Efficiency class: F
Grease Filtering Efficiency class: D
Air flow (min speed normal use): 234
Air flow (max speed normal use): 380
Air flow (intensive or boost use): 0
Airborne acoustical A-weighted sound power emissions (min speed normal use): 44
Airborne acoustical A-weighted sound power emissions (max speed normal use): 60
Power consumption in off mode (W): 0,00
Power consumption in standby mode (W): 0,00



DBB 90

ENERGY LABEL

