



# EWH 80 Water heater with vertical installation and 80L capacity



Dry Heating Protection



Humidity Control



Overheating Protection

**DESCRIPTION**

Water heater with vertical installation and 80L capacity

**LIFE STYLE**

Easy

**COLOURS**



**REFERENCE**

REF. 42080080  
EAN. 8421152069417



TEKA

**EWH 80**

## **FEATURES**

Capacity: 80 litres  
Sapphire enamelled tank  
Sapphire heating element  
Electrolytic muff  
Regulation of temperature: 30-75 °C  
Pressure valve > 5 bar  
Max. Input temperature: 0,75Mpa  
Thermometer  
Anti Over-pressure protection  
Overheat protection  
Anti Dry-heating Protection  
Waterproof Grade: IPX4  
Rated power output 1500 W  
Thickness of insulation: 20mm  
Water connection: G½  
Average number of users : 1-2/2-3/2-4/3-5

## DIMENSIONS

**Product height (mm):** 796  
**Product width (mm):** 450  
**Product depth (mm):** 450  
**Product length (mm):**  
**Net weight (Kg):** 25,25

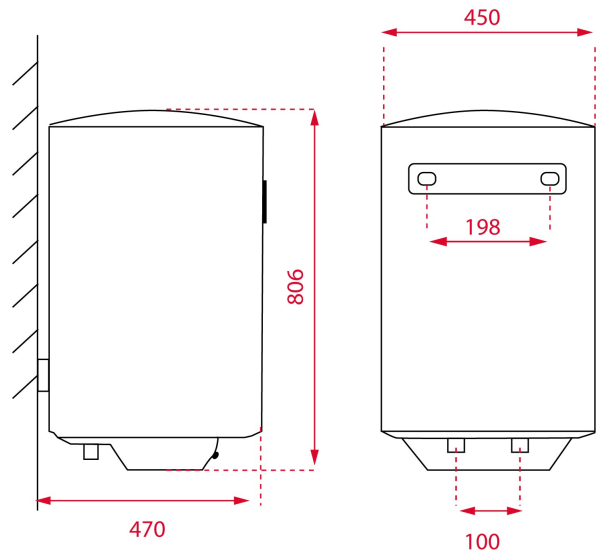

## TECH SPECS

### PARTICULAR CHARACTERISTICS

**Power rate (V):** 220-240  
**Frequency (Hz):** 50  
**Power rate (W):** 1.500  
**Plug type:** EU  
**Type of installation:** Vertical  
**Certificates:** CE;CB  
**Average number of users:** 2-4  
**Control panel:** MECHANICAL  
**Number of power levels:** 1  
**Maximum input pressure (Mpa):** 0,75  
**Sapphire Enamelled Steel Tank:** Yes  
**Magnesium protection anode:** Yes  
**Heating element indicator lamp:** Yes  
**Thermometer:** Yes  
**Insulation thickness (mm):** 20,00  
**Degree of protection against humidity:** IPX4  
**Protection against heating:** Yes  
**Dry heating protection:** Yes

**EU REGULATION NO.**  
**812/2013**

**Declared load profile:** M  
**Water heating energy efficiency class:** C  
**Annual energy consumption AEC kWh/annum (kWh):** 1356,00  
**Sound power level L WA (dB):** 15

**EU REGULATION NO.  
814/2013**

**Storage Volume V L (L): 80**



**EWH 80**

**ENERGY LABEL**

