



C 6310 60cm Classical integrated hood with 3 speeds and 1 motor



LED

DESCRIPTION

60cm Classical integrated hood with 3 speeds and 1 motor

LIFE STYLE

Easy

COLOURS



REFERENCE

REF. 40461541
EAN. 8421152146064

FEATURES

Classic hood
Operating pilot light
3 speeds
Exhaust capacities:
Free Outlet, m³/h: 254
Max., m³/h: 235
Min., m³/h: 124
Noise (LwA) Max Speed, dB: 62
Noise (LwA) Min Speed, dB: 45
2 Integrated LED lamps
3 aluminium filters

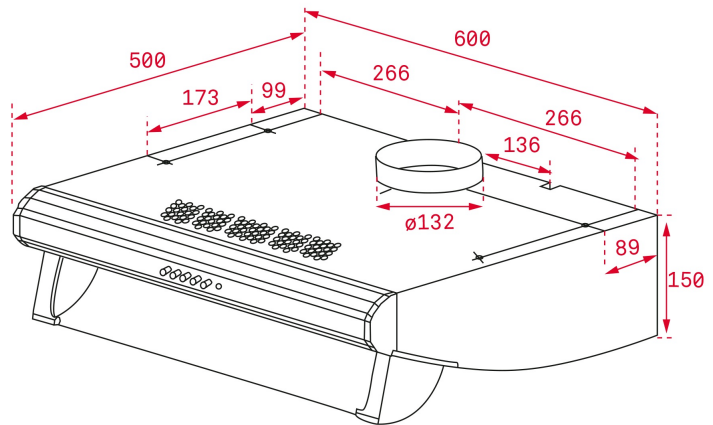

DIMENSIONS

Product height (mm): 150
Product width (mm): 600
Product depth (mm): 500
Product length (mm):
Net weight (Kg): 6,65

TECH SPECS

PARTICULAR CHARACTERISTICS

Type of hood: Classic
Style: Integrated
Certificates: CE; CB; Rohs
Ø Outlet (mm): 120
Type of inner light: LED
Inside light Consumption (W): 6
Plug type: European plug
Power rate (V): 220240
Frequency (Hz): 5060
Total hood power (W): 117
Number of motors: 1
Motor power (W): 105
Exhaust Capacity - Free Outlet (m3/h): 254

**EU REGULATION NO. 65/2014
&66/2104**

Annual energy consumption AEC kWh/annum (kWh): 67,1
Energy Efficiency Class: D
Fluid Dynamic Efficiency (FDEhood): 8,1
Fluid Dynamic Efficiency class: E
Light Efficiency (Lehood) lux/Watt: 4,8
Lighting Efficiency class: F

Grease Filtering Efficiency class: D
Air flow (Qmin) m3/h: 115
Air flow (Qmax): 235
Noise (LwA) Min Speed (dB): 45
Noise (LwA) Max Speed (dB): 66
Energy Efficiency Index (EEI): 91,0
Time increase factor: 1,7
Electric power input at best efficiency point (Wbep) W: 137,0
Nominal power of the lighting system (WL) W: 12
Average illumination of the lighting system on the cooking surface (Emiddle) Lux: 58

ACCESSORIES

Anti Return valve: Yes
Outlet extension: Yes
Optional Charcoal Filter: C2R
Charcoal filter description: CHARCOAL FILTER C2R

MODELS

Number of filters: 2
Filter description: Aluminum
Control panel: Slider
Number of speeds: 3

PRODUCT INFORMATION SHEET - DELEGATED REGULATION (EU) 65/2014

Supplier name or trademark: TEKA
Model identifier: C 6310
Annual Energy Consumption: 67,1
Energy Efficiency Class: D
Fluid Dynamic Efficiency: 8,1
Fluid Dynamic Efficiency class: E
Lighting Efficiency: 4,8
Lighting Efficiency class: F
Grease Filtering Efficiency class: D
Air flow (min speed normal use): 115
Air flow (max speed normal use): 235
Air flow (intensive or boost use): n.a
Airborne acoustical A-weighted sound power emissions (min speed normal use): 49
Airborne acoustical A-weighted sound power emissions (max speed normal use): 66
Power consumption in off mode (W): n.a
Power consumption in standby mode (W): n.a



C 6310

ENERGY LABEL

