



# DVT 985 90cm Vertical Hood with Contour Rim extraction system and Touch control display



LED



Perimeter extraction



Stop Delay Timer

**DESCRIPTION**

90cm Vertical Hood with Contour Rim extraction system and Touch control display

**LIFE STYLE**

Maestro

**COLOURS**



**REFERENCE**

REF. 40483572  
EAN. 8421152130711

**FEATURES**

Vertical decorative hood  
Eco power  
Touch control panel  
Rim extraction  
3 speeds + 1 intensive  
Exhaust capacities:  
Free Outlet (m<sup>3</sup>/h): 895  
Max. (m<sup>3</sup>/h): 786  
Min. (m<sup>3</sup>/h): 303  
Noise (LwA) Max Speed 66 dB  
Noise (LwA) Min Speed 52 dB  
LED illumination  
1 aluminium filter  
Stop delay timer  
Filter saturation indicator

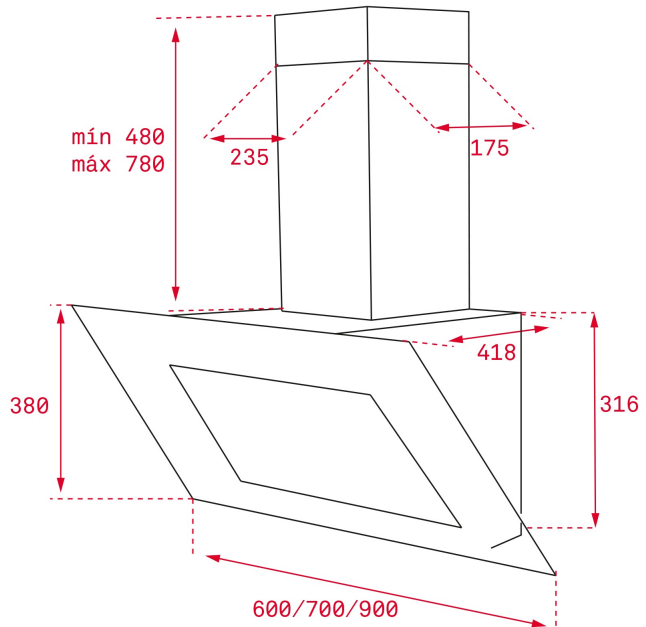

## DIMENSIONS

**Product height (mm):** 860-1160

**Product width (mm):** 900

**Product depth (mm):** 418

**Product length (mm):**

**Net weight (Kg):** 14,72

## TECH SPECS

### PARTICULAR CHARACTERISTICS

**Type of hood:** Vertical

**Style:** Decoratives

**Certificates:** CE; CB

**Ø Outlet (mm):** 150

**Type of inner light:** LED

**Inside light Consumption (W):** 3

**Plug type:** European plug

**Power rate (V):** 220240

**Frequency (Hz):** 50

**Total hood power (W):** 286

**Number of motors:** 1

**Motor power (W):** 280

**Exhaust Capacity - Free Outlet (m3/h):** 895

**EU REGULATION NO. 65/2014  
&66/2104**

**Annual energy consumption AEC kWh/annum (kWh):** 51,1

**Energy Efficiency Class:** A

**Fluid Dynamic Efficiency (FDEhood):** 32,3

**Fluid Dynamic Efficiency class:** A

**Light Efficiency (Lehood) lux/Watt:** 69,8

**Lighting Efficiency class:** A

**Grease Filtering Efficiency class:** C  
**Air flow (Qmin) m3/h:** 303  
**Air flow (Qmax):** 599  
**Air flow (Qboost):** 786  
**Noise (LwA) Min Speed (dB):** 52  
**Noise (LwA) Max Speed (dB):** 66  
**Noise (LwA) boost speed (dB):** 71  
**Off mode Power (Po) W:** 0,00  
**Standby Power (Ps) W:** 0,74  
**Energy Efficiency Index (EEI):** 47,9  
**Time increase factor:** 0,8  
**Electric power input at best efficiency point (Wbep) W:** 160,1  
**Nominal power of the lighting system (WL) W:** 6  
**Average illumination of the lighting system on the cooking surface (Emiddle) Lux:** 419

## ACCESSORIES

**Anti Return valve:** Yes  
**Outlet reduction:** Yes  
**Optional Charcoal Filter:** D4C  
**Charcoal filter description:** CHARCOAL FILTER D4C  
**Conventional recirculation kit (with tube cover):** 40490146

## MODELS

**Number of filters:** 1  
**Filter description:** Glass panel; aluminum filter below  
**Control panel:** Touch control white display  
**Stop delay timer:** Yes  
**Filter saturation indicator:** Yes  
**Number of speeds:** 3+1

## PRODUCT INFORMATION SHEET - DELEGATED REGULATION (EU) 65/2014

**Supplier name or trademark:** TEKA  
**Model identifier:** DVT 985  
**Annual Energy Consumption:** 51,1  
**Energy Efficiency Class:** A  
**Fluid Dynamic Efficiency:** 32,3  
**Fluid Dynamic Efficiency class:** A  
**Lighting Efficiency:** 69,8  
**Lighting Efficiency class:** A  
**Grease Filtering Efficiency class:** C  
**Air flow (min speed normal use):** 303  
**Air flow (max speed normal use):** 599  
**Air flow (intensive or boost use):** 786  
**Airborne acoustical A-weighted sound power emissions (min speed normal use):** 52  
**Airborne acoustical A-weighted sound power emissions (max speed normal use):** 66  
**Airborne acoustical A-weighted sound power emissions (intensive or boost use):** 71  
**Power consumption in off mode (W):** 0,00  
**Power consumption in standby mode (W):** 0,74



DVT 985

ENERGY LABEL

