



EWH 80 H Water heater with double installation system and 80L capacity



Dry Heating Protection



ELCB Earth Leakage Circuit Breaker



Humidity Control



Overheating Protection



Type of Installation

DESCRIPTION

Water heater with double installation system and 80L capacity

LIFE STYLE

Total

COLOURS

REFERENCE

REF. 42080280
EAN. 8421152131961



TEKA

EWH 80 H

FEATURES

Vertical and horizontal installation
Capacity: 80 litres
Sapphire enamelled tank
Sapphire heating element
Regulation of temperature: 30-75 °C
Pressure valve > 5 bar
Max. Input temperature: 0,75Mpa
Thermometer
Anti Over-pressure protection
Earth leakage circuit breaker ELCB
Overheat protection
Anti Dry-heating Protection
Waterproof Grade: IPX4
Rated power output 1500 W
Thickness of insulation: 20mm
Water connection: G½
Average number of users: 2-4



EWH 80 H

DIMENSIONS

- Product height (mm): 1030
- Product width (mm): 385
- Product depth (mm): 385
- Product length (mm):
- Net weight (Kg): 26,31

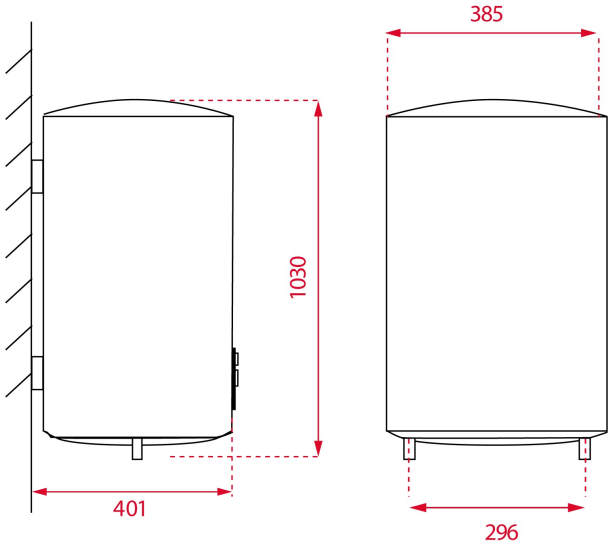



EWH 80 H

ENERGY LABEL

