



DBB 60 60cm Pyramidal Decorative Hood with push buttons controls



LED

DESCRIPTION

60cm Pyramidal Decorative Hood with push buttons controls

LIFE STYLE

Easy

COLOURS



REFERENCE

REF. 40460402
EAN. 8421152069622



TEKA

DBB 60

FEATURES

Pyramidal decorative hood
Push buttons control panel
Operating Pilot Light
Conventional aspiration
3 speeds
Exhaust capacities:
Free Outlet (m³/h): 475
Max. (m³/h): 380
Min. (m³/h): 234
Noise (LwA) Max Speed 60 dB
Noise (LwA) Min Speed 44 dB
Incandescent Lamps
2 aluminum filters

DIMENSIONS

Product height (mm): 749-1049
Product width (mm): 600
Product depth (mm): 480
Product length (mm):
Net weight (Kg): 7,4

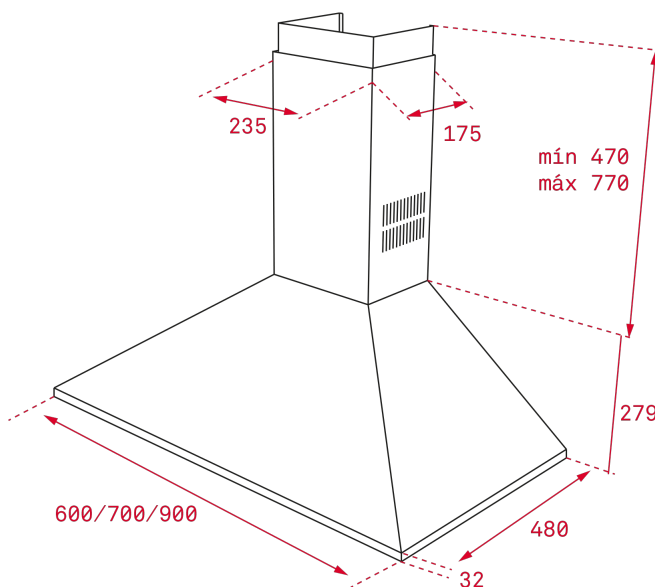

TECH SPECS

PARTICULAR CHARACTERISTICS

Type of hood: Pyramidal
Style: Decoratives
Certificates: CE; CB
Ø Outlet (mm): 150
Type of inner light: LED
Inside light Consumption (W): 5
Plug type: European plug
Power rate (V): 220/240
Frequency (Hz): 50/60
Total hood power (W): 115
Number of motors: 1
Motor power (W): 105
Exhaust Capacity - Free Outlet (m³/h): 475

**EU REGULATION NO. 65/2014
&66/2104**

Annual energy consumption AEC kWh/annum (kWh): 62,3
Energy Efficiency Class: D
Fluid Dynamic Efficiency (FDEhood): 6,9
Fluid Dynamic Efficiency class: F
Light Efficiency (Lehood) lux/Watt: 5,9
Lighting Efficiency class: F

Grease Filtering Efficiency class: D
Air flow (Qmin) m3/h: 234
Air flow (Qmax): 380
Air flow (Qboost): 0
Noise (LwA) Min Speed (dB): 44
Noise (LwA) Max Speed (dB): 60
Noise (LwA) boost speed (dB): 0
Off mode Power (Po) W: 0,00
Standby Power (Ps) W: 0,00
Energy Efficiency Index (EEI): 93,3
Time increase factor: 1,8
Electric power input at best efficiency point (Wbep) W: 83,7
Nominal power of the lighting system (WL) W: 10
Average illumination of the lighting system on the cooking surface (Emiddle) Lux: 59

ACCESSORIES

Anti Return valve: Yes
Outlet reduction: Yes
Optional Charcoal Filter: D4C
Charcoal filter description: CHARCOAL FILTER D4C
Conventional recirculation kit (with tube cover): 40490146

MODELS

Number of filters: 2
Filter description: Aluminum
Control panel: Rectangular Push Buttons
Number of speeds: 3

PRODUCT INFORMATION SHEET - DELEGATED REGULATION (EU) 65/2014

Supplier name or trademark: TEKA
Model identifier: DBB 60
Annual Energy Consumption: 62,3
Energy Efficiency Class: D
Fluid Dynamic Efficiency: 6,9
Fluid Dynamic Efficiency class: F
Lighting Efficiency: 5,9
Lighting Efficiency class: F
Grease Filtering Efficiency class: D
Air flow (min speed normal use): 234
Air flow (max speed normal use): 380
Air flow (intensive or boost use): 0
Airborne acoustical A-weighted sound power emissions (min speed normal use): 44
Airborne acoustical A-weighted sound power emissions (max speed normal use): 60
Power consumption in off mode (W): 0,00
Power consumption in standby mode (W): 0,00



DBB 60

ENERGY LABEL

