



DVN 74030 TTC 70cm Vertical Decorative Hood with Touch control and Rim Extraction



LED



Perimeter extraction



Stop Delay Timer

DESCRIPTION

70cm Vertical Decorative Hood with Touch control and Rim Extraction

LIFE STYLE

Easy

COLOURS



REFERENCE

REF. 112950006
EAN. 8434778010787



DVN 74030 TTC

FEATURES

Vertical decorative hood
Energy efficiency class: C
Extraction rim system "Contour"
Touch control panel
2 speeds + 1 intensive
Exhaust capacities:
Free Outlet (m³/h): 460
Max. (m³/h): 410
Min. (m³/h): 380
Noise (LwA) Max Speed 66 dB
Noise (LwA) Min Speed 65 dB
LED illumination
1 aluminium filter with 4 layers
Stop delay timer
Filter saturation indicator
Recirculation function optional Set D11CTP
Regenerative Charcoal filters optional

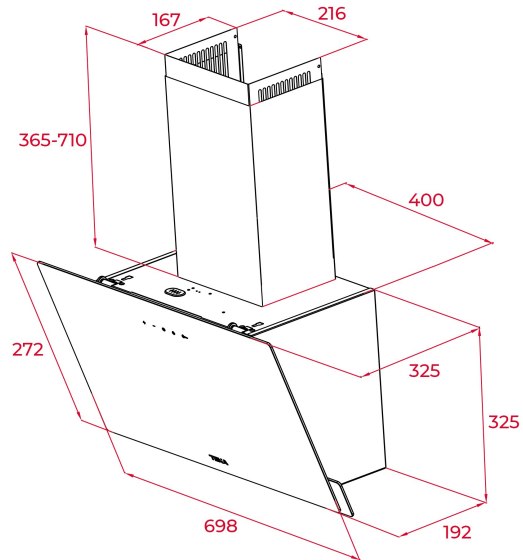

DIMENSIONS

Product height (mm): 690-1035

Product width (mm): 698

Product depth (mm): 325

Product length (mm):

Net weight (Kg): 9,02

TECH SPECS

PARTICULAR CHARACTERISTICS

Type of hood: Vertical

Style: Decoratives

Certificates: CE; CB; EMC

Ø Outlet (mm): 150

Type of inner light: LED

Inside light Consumption (W): 1

Plug type: schuko

Cable Connection Length (cm): 160

Power rate (V): 220/240

Frequency (Hz): 50/60

Total hood power (W): 142

Number of motors: 2

Motor power (W): 140

Exhaust Capacity - Free Outlet (m³/h): 460

**EU REGULATION NO. 65/2014
&66/2104**

Annual energy consumption AEC kWh/annum (kWh): 60,2

Energy Efficiency Class: C

Fluid Dynamic Efficiency (FDEhood): 11,05

Fluid Dynamic Efficiency class: E

Light Efficiency (Lehood) lux/Watt: 76,1

Lighting Efficiency class: A
Grease Filtering Efficiency class: C
Air flow (Qmin) m3/h: 380
Air flow (Qmax): 410
Air flow (Qboost): 425
Noise (LwA) Min Speed (dB): 65
Noise (LwA) Max Speed (dB): 66
Noise (LwA) boost speed (dB): 67
Standby Power (Ps) W: 0,49
Energy Efficiency Index (EEI): C
Time increase factor: 1,6
Electric power input at best efficiency point (Wbep) W: 101
Nominal power of the lighting system (WL) W: 2
Average illumination of the lighting system on the cooking surface (Emiddle) Lux: 152

ACCESSORIES

Anti Return valve: Yes
Outlet reduction: Yes
Outlet extension: no
Optional Charcoal Filter: D9C
Charcoal filter description: CHARCOAL FILTER D9C INTEGRA (set 2 u.)
Conventional recirculation kit (with tube cover): 113290007

MODELS

Number of filters: 1
Filter description: Aluminum Filters
Opening system: Panel Uphold Hinge
Control panel: Touch Control
Stop delay timer: Yes
Number of speeds: 2+1

PRODUCT INFORMATION SHEET - DELEGATED REGULATION (EU) 65/2014

Supplier name or trademark: TEKA
Model identifier: DVN 74030 TTC
Annual Energy Consumption: 60,2
Energy Efficiency Class: C
Fluid Dynamic Efficiency: 11,05
Fluid Dynamic Efficiency class: E
Lighting Efficiency: 76,1
Lighting Efficiency class: A
Grease Filtering Efficiency class: C
Air flow (min speed normal use): 380
Air flow (max speed normal use): 410
Air flow (intensive or boost use): 425
Airborne acoustical A-weighted sound power emissions (min speed normal use): 65
Airborne acoustical A-weighted sound power emissions (max speed normal use): 0
Airborne acoustical A-weighted sound power emissions (intensive or boost use): 67
Power consumption in off mode (W): n.a.
Power consumption in standby mode (W): 0,49



DVN 74030 TTC

ENERGY LABEL

