









MaestroPizza HLB 8510 P MaestroPizza Pyrolitic Oven with special Pizza funtion 340°C



-  70L
-  DualClean
-  HydroClean
-  Plus Extension Telescopic Guide
-  Pyrolysis
-  SoftClose
-  SurroundTemp

DESCRIPTION

MaestroPizza Pyrolitic Oven with special Pizza funtion 340°C

LIFE STYLE

Maestro

COLOURS



REFERENCE

REF. 111000046
EAN. 8434778017489

FEATURES

MaestroPizza Oven
340°C extra Powerfull grill
Includes special stone for cooking pizza
Pyrolytic function and HydroClean® PRO cleaning system
Multifunction SurroundTemp - 8 Cooking functions
SoftClose System
Capacity, gross/net: 71/70 litres
A+ Energy class: up to 20% less consumption
Touch Control Programmer
Telescopic Guides Easy Slide
Express preheating function
Four glazed door
Special baking tray for pizza
Anti-tip deep & baking trays and cooking grid
Children safety block option

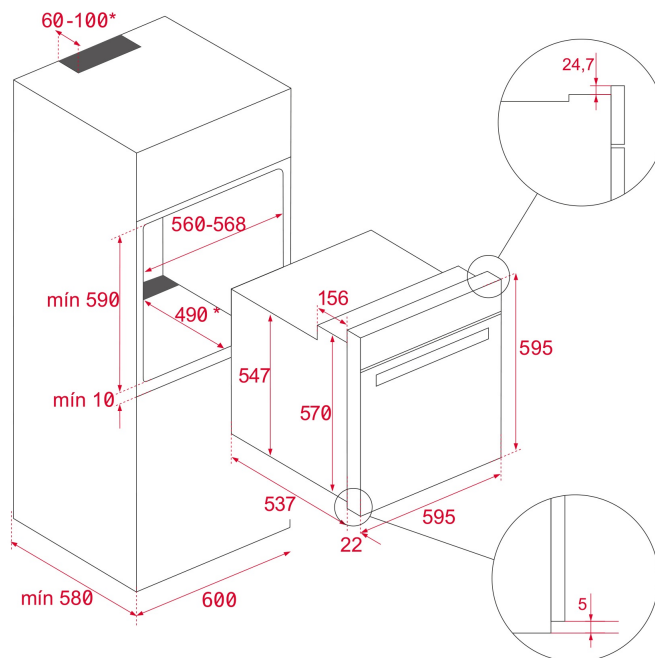

DIMENSIONS

Product height (mm): 595

Product width (mm): 595

Product depth (mm): 537+22

Product length (mm):

Net weight (Kg): 34

TECH SPECS

PARTICULAR CHARACTERISTICS

Certificates: CE

Number of cavities: 1

Type of inner light: Halogen

Inside light position: RIGHT TOP CORNER

Enamelled cavity: Yes

Min. Temperature Regulator (°C): 50

Max. Temperature Regulator (°C): 250

Function selector: 11+0

Number of cooking functions: 8

Top + Bottom function: Yes

Grill function: Yes

MaxiGrill function: Yes

Bottom + TURBO (Pizza) function: Yes

Turbo function: Yes

ECO function: Yes

Mechanical quick heating: Yes

Touch Control Programmer: Yes

Knobs type: MMX FIX knurling SS

Removable chromed tray guides: Yes

Number of guide levels: 5

Easy slide telescopic guides: Yes

SoftClose: Yes

ELECTRIC CONNECTION

Maximum Nominal Power (W): 3552

Frequency (Hz): 50/60

Power rate (V): 220-240

Cable Connection Length (cm): 150

Plug: Yes

Inside light Consumption (W): 25

ENERGY CONSUMPTION

Energy consumption per cycle in conventional mode (kWh):

0.88

Energy consumption per cycle in fan-forced convection mode

(kWh): 0,68

Bottom Heating Element (W): 1050

Grill (W): 1400

Maxi Grill (W): 2450

Traditional (W): 2450

Turbo (W): 2000

Multifunction Turbo (W): 25

Cooling Fan Motor (W): 30

SECURITY SYSTEM

Automatic disconnection when opening the door: Yes

Panel blocking system: Yes

Children safety block option: Yes

Grill protection: Yes

Anti-tip tray system: Yes

Safety Thermostat: Yes

CLEANING SYSTEM

Crystal Clean Enamel (Slippery): Yes

Hydroclean PRO: Yes

Pyrolytic: Yes

DualClean: Yes

ACCESSORIES

Baking Tray: 1

Deep Tray (50 mm): 1

Reinforced grid: 1

ENERGY EFFICIENCY

Energy Efficiency Class: A+

Energy Efficiency Index (EEI): 81



MaestroPizza HLB 8510 P

ENERGY LABEL

ENERG Y UA IE IA
енергия - ενεργεια

TEKA HLB 8510 P

A+++
A++
A+
A
B
C
D

A+

70 L

0.88 kWh/cycle*
0.68 kWh/cycle*

* цилья - cyclus - portion - zykus - porcyoция - ciclo - tsükkel - ohjelma - ciklus - ciklas - ciklo - ciklu - cyclus - cykl - ciclo - program - cykel
65/2014