



**MLC 8440** 45cm Urban Colors Edition Built-in Microwave + Grill



Defrost By  
Time



Defrost By  
Weight



44L

**DESCRIPTION**

45cm Urban Colors Edition Built-in Microwave + Grill

**LIFE STYLE**

Maestro

**COLOURS**



**REFERENCE**

REF. 111160004  
EAN. 8434778007664



TEKA

MLC 8440

## FEATURES

Urban Colors Edition  
Microwave + Grill – 3 Cooking functions  
Capacity, gross/net: 45/44 litres  
1400 W grill  
0-90 min. Timer  
Quick start 30  
chromed guides  
5 Cooking heights  
1 reinforced grids  
Touch Control panel with LED display  
5 power levels, 1000 W  
Automatic disconnection security system  
Tangential ventilation  
Defrost by time and weight  
Double Glazed door

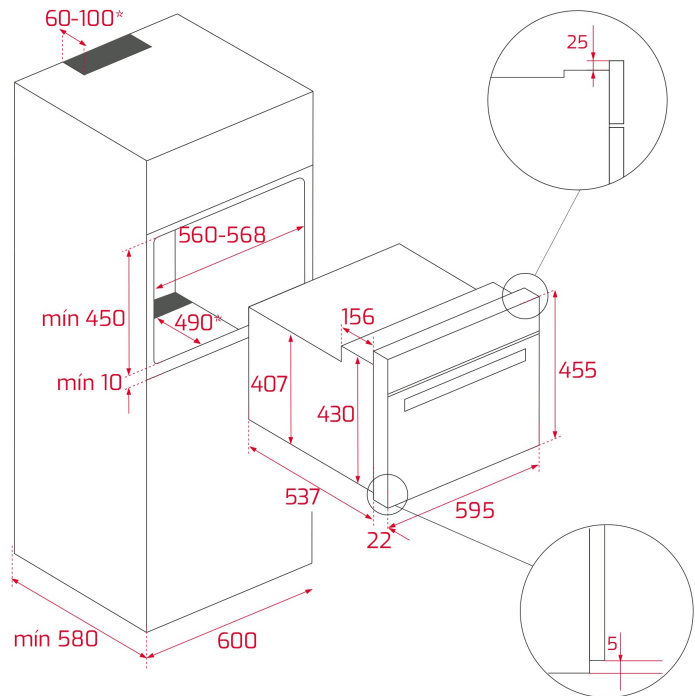

## DIMENSIONS

**Product height (mm):** 455  
**Product width (mm):** 595  
**Product depth (mm):** 559  
**Product length (mm):**  
**Net weight (Kg):** 28,4

## TECH SPECS

### PARTICULAR CHARACTERISTICS

**Certificates:** CE/CB  
**Number of cavities:** 1  
**Type of inner light:** Halogen  
**Inside light position:** Top rear right  
**Enamelled cavity:** Yes  
**Function selector:** MECHANICAL  
**Number of cooking functions:** 3  
**Grill function:** Yes  
**Touch Control Programmer:** Yes  
**Minute Minder:** Yes  
**Knobs type:** MMX FIX KNOB  
**Removable chromed tray guides:** Yes  
**Number of guide levels:** 5  
**Number of guide levels (lower cavity):** 0  
**Forced refrigeration tangential 1 speed:** Yes  
**Microwave function:** Yes  
**Microwave defrosting:** Yes  
**Number of power levels:** 5  
**Tangential ventilation:** Yes

### ELECTRIC CONNECTION

**Maximum Nominal Power (W):** 3200  
**Frequency (Hz):** 50  
**Power rate (V):** 220-240  
**Cable Connection Length (cm):** 110  
**Inside light Consumption (W):** 25

## **ENERGY CONSUMPTION**

**Grill (W):** 1400  
**Cooling Fan Motor (W):** 18

## **SECURITY SYSTEM**

**Automatic disconnection when opening the door:** Yes  
**Grill protection:** Yes  
**Safety Thermostat:** Yes  
**Full glazed doors:** 2

## **CLEANING SYSTEM**

**Fingerprint proof stainless steel:** Yes  
**Crystal Clean Enamel (Slippery):** Yes

## **ACCESSORIES**

**Reinforced grid:** Yes

