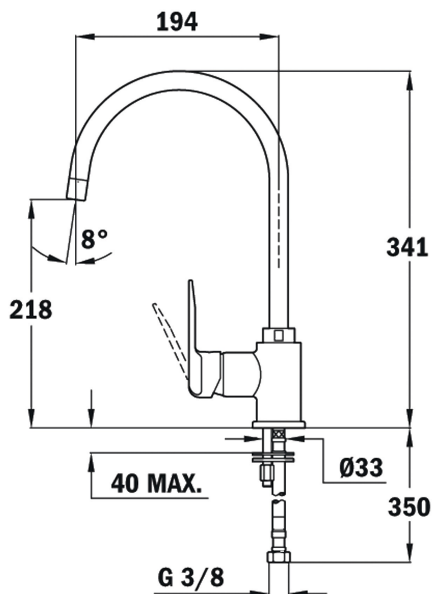

Anti-Scale
AeratorSwivel
Spout

REFERENCIA

REF: 53995120FW

EAN: 8421152137123

CARACTERÍSTICAS

Diseño minimalista

Caño giratorio

Cartucho de discos cerámicos de alta resistencia

Preciso control de la temperatura

Mayor suavidad en el manejo







Aireador anticalcáreo

Latiguillos flexibles de alimentación de 3/8"

DIMENSIONES

Altura del producto (mm): 341**Anchura del producto (mm):****Profundidad del producto (mm):****Longitud del producto (mm):****Peso del producto (Kg):** 1,55

COLORES

	53995120FW	Blanco
	53995120FN	Naranja
	53995120FN	Negro
	53995120FN	Azul
	53995120FN	Blanco
	53995120FN	Rosa