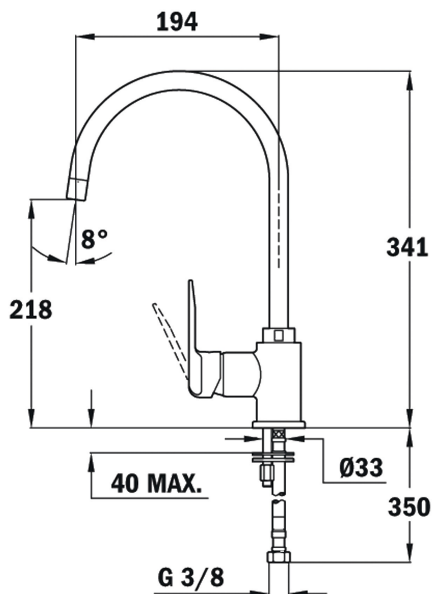

Anti-scale
aeratorSwivel
spout

REFERENCE

REF: 53995120FW

EAN: 8421152137123

FEATURES

High spout kitchen tap
 Minimalistic design
 Swivel spout
 Anti-scale aerator
 Cartridge with ceramic discs of high resistance
 Highly precise temperature control
 Greater handling sensitivity with smoother movements
 3/8" flexible inlet pipes

DIMENSIONS

Product height (mm): 341







Product width (mm):

Product depth (mm):

Product length (mm):

Net weight (Kg): 1,55

COLOURS

	53995120FW	White
	53995120FM	Black
	53995120FM	Carbon
	53995120FM	Sandbeige
	53995120FM	Metallic black
	53995120FM	Chrome
	53995120FM	Grey