

**Stone 80 B-TG 2B 1D**

Inset Tegrinite sink with two bowls and one drainer

**REFERENCE**

REF: 115400014

EAN: 8434778004960

**FEATURES**

Stone Series

Tegrinite+ sink

Two bowls and one drainer

High resistance surface to impacts, thermal shocks and high temperatures

Excellent UV resistance against decoloring

Bacteria-free surface very easy to clean

Inset installation

80% quartz and resins

3½" automatic basket waste with siphon

200 mm deep bowls

80 cm base unit





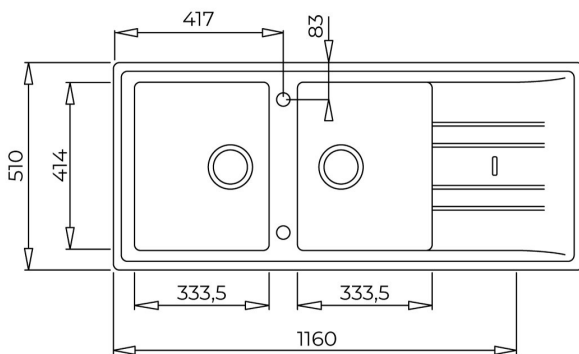

200mm  
depthColour  
Intensity

Easy Clean



Food safe

High  
resistance**DIMENSIONS****Product height (mm):****Product width (mm):** 510**Product depth (mm):** 200**Product length (mm):** 1160**Net weight (Kg):** 18,5**COLOURS**

	115400014	Dark grey
	115400010	Carbon
	115400010	Metallic grey
	115400010	White
	115400010	Topasbeige
	115400010	Metallic black
	115400010	Sandbeige